



Installation and Setup Guide

020-103907-01

Cinema 2K-RBe

CP2406-RBe, CP2409-RBe, and CP2411-RBe

CHRISTIE®

NOTICES

COPYRIGHT AND TRADEMARKS

Copyright © 2024 Christie Digital Systems USA Inc. All rights reserved.

All brand names and product names are trademarks, registered trademarks or trade names of their respective holders.

GENERAL

Every effort has been made to ensure accuracy, however in some cases changes in the products or availability could occur which may not be reflected in this document. Christie reserves the right to make changes to specifications at any time without notice. Performance specifications are typical, but may vary depending on conditions beyond Christie's control such as maintenance of the product in proper working conditions. Performance specifications are based on information available at the time of printing. Christie makes no warranty of any kind with regard to this material, including, but not limited to, implied warranties of fitness for a particular purpose. Christie will not be liable for errors contained herein or for incidental or consequential damages in connection with the performance or use of this material. Our centers of excellence for manufacturing in Kitchener, Ontario, Canada and in Shenzhen, China are ISO 9001:2015 Quality Management System-certified.

Christie is committed to making our documents free from language bias; however, we are not responsible for the language used on any linked or third-party documentation.

For the most current technical documentation and office contact information, visit <https://www.christiedigital.com/>.

Warranty

Products are warranted under Christie's standard limited warranty, the details of which are available at <https://www.christiedigital.com/help-center/warranties/> or by contacting your Christie dealer or Christie.

PREVENTATIVE MAINTENANCE

Preventative maintenance is an important part of the continued and proper operation of your product. Failure to perform maintenance as required, and in accordance with the maintenance schedule specified by Christie, voids the warranty. For preventative maintenance schedules, refer to www.christiedigital.com.

REGULATORY

The product has been tested and found to comply with the limits for a Class A digital device, pursuant to Part 15 of the FCC Rules. These limits are designed to provide reasonable protection against harmful interference when the product is operated in a commercial environment. The product generates, uses, and can radiate radio frequency energy and, if not installed and used in accordance with the instruction manual, may cause harmful interference to radio communications. Operation of the product in a residential area is likely to cause harmful interference in which case the user will be required to correct the interference at the user's own expense. Changes or modifications not expressly approved by the party responsible for compliance could void the user's authority to operate the equipment

CAN ICES-3 (A) / NMB-3 (A)

이 기기는 업무용(A급)으로 전자파적합등록을 한 기기이오니 판매자 또는 사용자는 이점을 주의하시기 바라며, 가정 외의 지역에서 사용하는 것을 목적으로 합니다.

ENVIRONMENTAL



The product is designed and manufactured with high-quality materials and components that can be recycled and reused. This symbol  means electrical and electronic equipment, at their end-of-life, should be disposed of separately from regular waste. Please dispose of the product appropriately and according to local regulations. In the European Union, separate collection systems are for used electrical and electronic products.

If printing this document, consider printing only the pages you need and select the double-sided option.

Please help us to conserve the environment we live in!

Notation

Learn the hazard and information symbols used in the product documentation.



Danger messages indicate a hazardous situation which, if not avoided, results in death or serious injury.



Warning messages indicate a hazardous situation which, if not avoided, could result in death or serious injury.



Caution messages indicate a hazardous situation which, if not avoided, could result in minor or moderate injury.



Notice messages indicate a hazardous situation which, if not avoided, may result in equipment or property damage.



Information messages provide additional information, emphasize or provide a useful tip.

Content

Introduction.	6
Product documentation.	6
Related documentation.	6
Important safeguards.	6
General safety precautions.	7
Laser safety precautions.	7
AC/power precautions.	8
Light intensity hazard distance.	8
Product labels.	13
General hazards.	13
Mandatory actions.	15
Electrical labels.	15
Laser hazards.	15
Additional hazard labels.	16
Contact your dealer.	16
Key features.	16
List of components.	16
Accessories.	17
Technical support.	18
Installing and setting up.	19
Site requirements.	19
Power specifications.	20
Projector components.	21
Preparing the installation site.	21
Lifting and positioning the projector.	22
Connecting to an uninterruptable power supply.	22
Installing the lens.	23
Installing the touch panel (optional).	25
Projector power modes.	25
Using the web user interface (Web UI).	25
Turning on or off the projector.	26
Logging into the projector.	26
Turning on or off the light source.	26

Selecting Integrated Media Block (IMB) preferences.	27
Activating marriage.	27
Disposing of the product packaging.	27
Completing the installation checklist.	27
Video Input panel.	28
HDMI video source.	29
HDMI video formats.	29
Integrated Media Block (IMB) video source.	31
Series 2 Integrated Media Block (IMB) video formats.	31
Series 4 Integrated Media Block (IMB) video formats.	33
HDMI video source connection from an Integrated Media Block (IMB).	35
SDI video source connection from an Integrated Media Block (IMB).	36
GPIO connector.	36
Managing the light source.	40
Creating a new laser file.	40
Modifying an existing laser file.	41
Copying existing laser settings to a new file.	41
Deleting a laser file.	41
LiteLOC™ sensor-to-screen calibration	42
LiteLOC™ sensor-to-screen calibration: Workflow.	42
Creating a new calibration file.	42
Recalibrating an existing calibration file.	44
Editing the existing calibration file parameters.	45
Verifying the sensor-to-screen calibration	45
Adding a calibration file to the Channel Setup.	46
Adjusting the image.	47
Calibrating the Intelligent Lens System.	47
Correcting vignetting.	47
Adjusting tilt and leveling the projector.	47
Installing the extension feet.	48
Correcting keystone effect.	49
Adjusting the fold mirror.	49
Displaying a test pattern.	50
Aligning the boresight.	51
Mechanically adjusting digital micromirror device (DMD) convergence	54
Electronic Color Correction (ECC).	56

Electronically adjusting convergence.56

Correcting on-screen color.58

Regulatory. 59

 Safety. 59

 Electro-magnetic compatibility. 59

 Emissions. 59

 Immunity. 59

 California law on security.60

 Environmental. 60

Introduction

This manual is intended for professionally trained operators of Christie high-brightness Cinema 2K-RBe projection systems.

Only trained Christie qualified technicians who are knowledgeable about the hazards associated with high-voltage, laser safety, and the high temperatures generated by the projector are authorized to assemble and install the projector. Only Christie qualified technicians are authorized to service the projector.

For complete product documentation and technical support, go to www.christiedigital.com.

Product documentation

For installation, setup, and user information, see the product documentation available on the Christie Digital Systems USA Inc. website. Read all instructions before using or servicing this product.

1. Access the documentation from the Christie website:
 - Go to this URL: <https://bit.ly/3vxrm4Y> or <https://www.christiedigital.com/products/cinema/projection/cinelife-plus-series/>.
 - Scan the QR code using a QR code reader app on a smartphone or tablet.



2. On the product page, select the model and switch to the **Downloads** tab.

Related documentation

Additional information on this product is available in the following documents.

- *Cinema 2K-RBe Service Guide (P/N: 020-103908-XX)*
- *CineLife+ 2.0 User Guide (P/N: 020-103845-XX)*
- *CineLife+ Serial Commands Guide (P/N: 020-103075-XX)*

Important safeguards

To prevent personal injury and to protect the device from damage, read and follow these safety precautions. This projector is intended for use in a cinema environment.

General safety precautions

Read all safety and warning guidelines before installing or operating the projector.



Warning! If not avoided, the following could result in death or serious injury.

- TRIP OR FIRE HAZARD! Position all cables where they cannot contact hot surfaces, be pulled, be tripped over, or damaged by persons walking on or objects rolling over the cables.
- This product must be installed within a restricted access location not accessible by the general public.
- Only personnel who are trained on the precautions for the restricted access location can be granted entry to the area.
- Install the product so users and the audience cannot enter the restricted area at eye level.
- ELECTRICAL and BURN HAZARD! Use caution when accessing internal components.
- FIRE AND SHOCK HAZARD! Use only the attachments, accessories, tools, and replacement parts specified by Christie.
- FIRE HAZARD! Do not use a power cord, harness, or cable that appears damaged.
- HAZARDOUS SUBSTANCE! Use caution when handling the product as it contains ethylene glycol. Do not ingest coolant. For information on safe handling, refer to the Safety Data Sheet (SDS) for the coolant.
- RADIATION HAZARD! Use of controls or adjustments, or performing procedures other than those specified may result in hazardous radiation exposure.
- Do not install or operate the projector in any position that does not meet the stated product specifications for alignment and orientation.



Caution! If not avoided, the following could result in minor or moderate injury.

- Only Christie qualified technicians are permitted to open product enclosures.

Laser safety precautions

Read all safety and warning guidelines before operating the projector laser.



Warning! If not avoided, the following could result in death or serious injury.

- Do not operate the cinema projector without all of its covers in place.
- LASER RADIATION HAZARD! This projector has a built-in Class 4 laser module. Never attempt to disassemble or modify the laser module.
- Do not look directly into the lens when the light source is on. The extremely high brightness can cause permanent eye damage.
- Possible hazardous optical radiation emitted from this product. (Risk group 3)

AC/power precautions

Read all safety and warning guidelines before connecting to AC power.



Warning! If not avoided, the following could result in death or serious injury.

- SHOCK HAZARD! Only use the AC power cord provided with the product or recommended by Christie.
- FIRE AND SHOCK HAZARD! Do not attempt operation unless the power cord, power socket, and power plug meet the appropriate local rating standards.
- SHOCK HAZARD! Do not attempt operation if the AC supply is not within the specified voltage and current, as specified on the license label.
- SHOCK HAZARD! The AC power cord must be inserted into an outlet with grounding. SHOCK HAZARD! The optional UPS power cord must be inserted into an outlet with grounding.
- SHOCK HAZARD! A dedicated, protected ground or earth wire must be installed on the product by Christie qualified technicians or electricians before it can be connected to power.
- SHOCK HAZARD! Disconnect the product from AC before installing, moving, servicing, cleaning, removing components, or opening any enclosure.
- Install the product near an easily accessible AC receptacle.
- Always connect the ground or earth first to reduce shock hazard.
- A certified electrician must be present during installation to make sure the installation meets the local electrical code.



Caution! If not avoided, the following could result in minor or moderate injury.

- Use an appropriately sized strain relief connector with the knockout plate provided, to make sure adequate environmental sealing and to prevent the AC supply cable from accidentally being torn out or rubbing against the knockout plate.
- FIRE HAZARD! Do not use a power cord, harness, or cable that appears damaged.
- FIRE OR SHOCK HAZARD! Do not overload power outlets and extension cords.
- SHOCK HAZARD! Power supply uses double pole/neutral fusing.

Light intensity hazard distance

This projector has been classified as Risk Group 3 as per the IEC 62471-5:2015 standard due to possible hazardous optical and thermal radiation being emitted.



Warning! If not avoided, the following could result in serious injury.

- PERMANENT/TEMPORARY BLINDNESS HAZARD! No direct exposure to the beam must be permitted. Class 1 Laser Product - Risk Group 3 according to IEC 60825-1:2014 and IEC 62471-5:2015.
- PERMANENT/TEMPORARY BLINDNESS HAZARD! Operators must control access to the beam within the hazard distance or install the product at the height that prevents exposure of spectators' eyes within the hazard distance. The hazard zone must be no lower than 2.5 meters/8.2 feet (US installations) or 2.0 meters/6.6 feet (global installations) above any surface upon which any persons are permitted to stand and the horizontal clearance to the hazard zone must be a minimum 1.0 meters (3.3 feet).
- EXTREME BRIGHTNESS! Do not place reflective objects in the product light path.

The following show the zones for ocular and skin hazard distances.

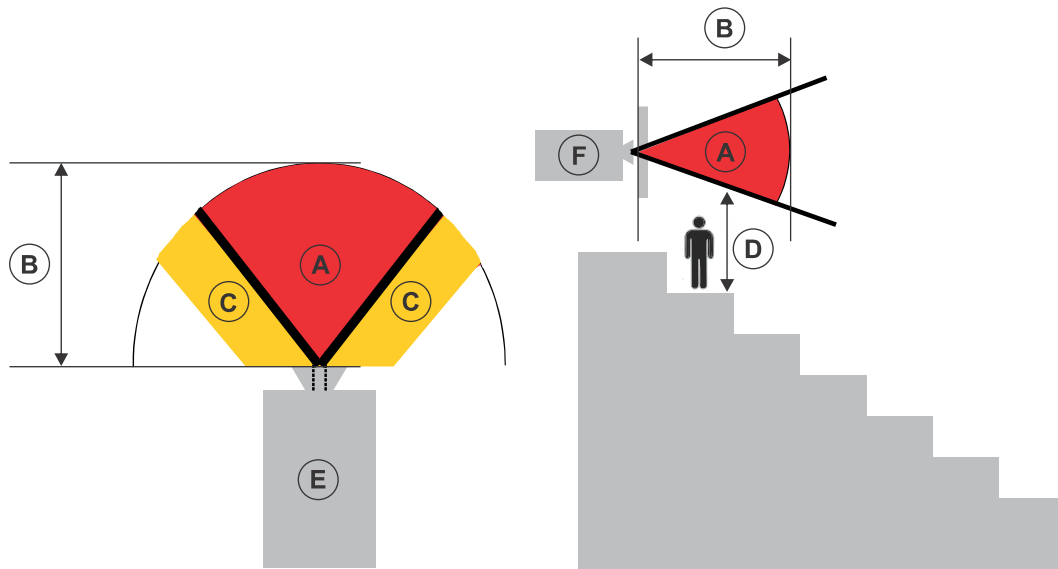

- A—Hazard zone. The region of space where the projection light from the laser-illuminated projector is above emission limits for Risk Group 2. The light intensity may cause eye damage after a momentary or brief exposure (before a person can avert their eyes away from the light source). The light may cause skin burns to occur.
- B—Hazard distance. Operators must control access to the beam within the hazard distance or install the product preventing potential exposure of the spectators' eyes from being in the hazard distance.
- C—No access zone. Horizontal clearance of the no access zone must be a minimum of 1.0 meters (3.3 feet).
- D—Vertical distance to hazard zone. The hazard zone must be no lower than 2.5 meters/8.2 feet (US installations) or 2.0 meters/6.6 feet (global installations) above any surface upon which any persons are permitted to stand.
If the vertical distance to hazard zone requirement (Zone D) is satisfied, the horizontal clearance distance (Zone C) is not needed.
- E—Represents the top view of the projector.
- F—Represents the side view of the projector.

The following table lists the hazard distance for the Christie projector lens with the zoom adjusted to its most hazardous position.

Projection lens	Part number	Hazard distance (m)	Category
0.83-1.2:1	108-498102-XX	N/A	RG2
1.2-1.72:1 DLP Cine zoom	108-494108-XX	See hazard distance graphs below	RG3
1.33-2.1:1 DLP Cine zoom	108-495109-XX		
1.62-2.7:1 DLP Cine zoom	108-496100-XX		
2.09-3.9:1 DLP Cine zoom	108-497101-XX		

CP2406-RBe hazard distance graph

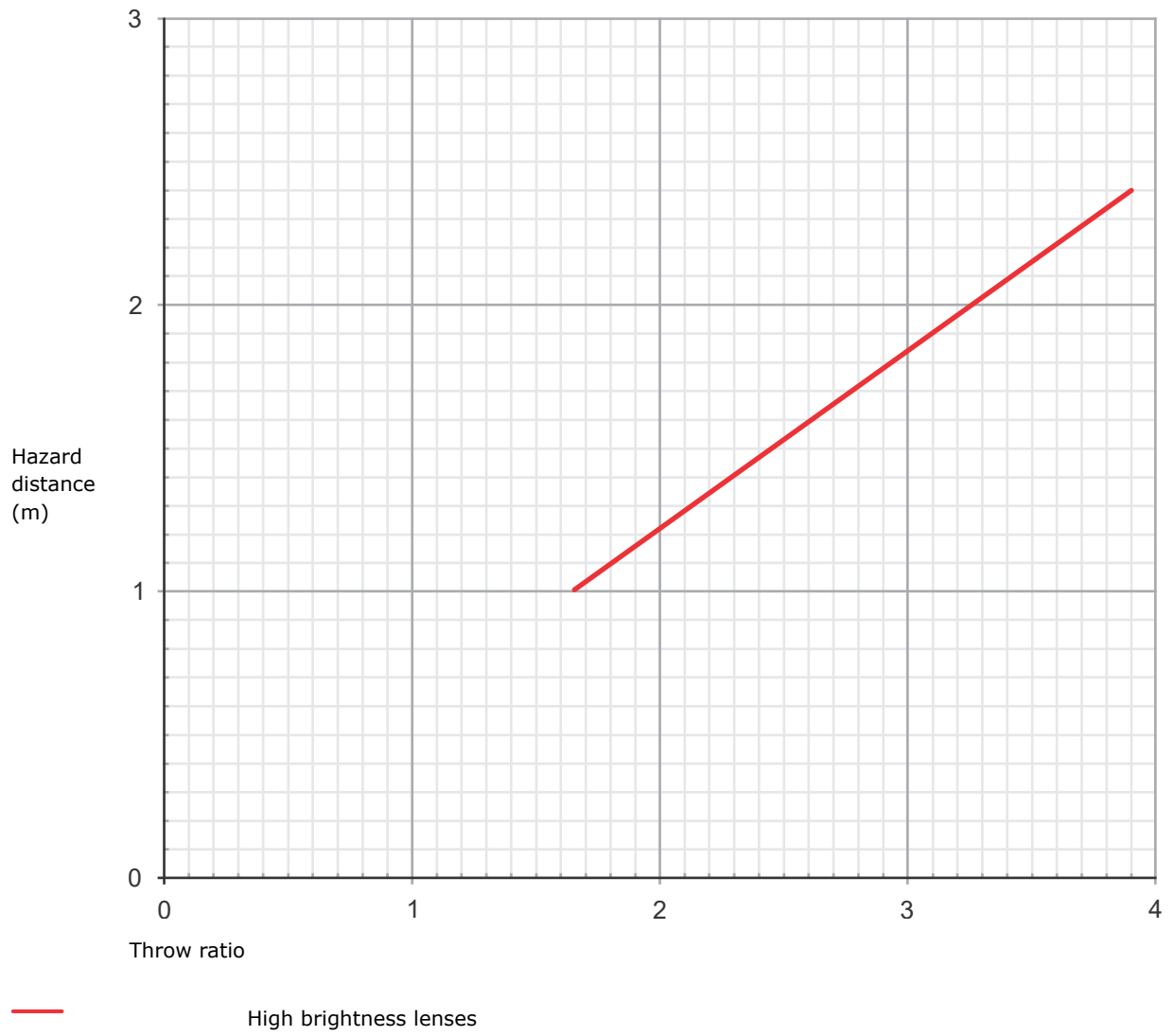

CP2409-RBe hazard distance graph

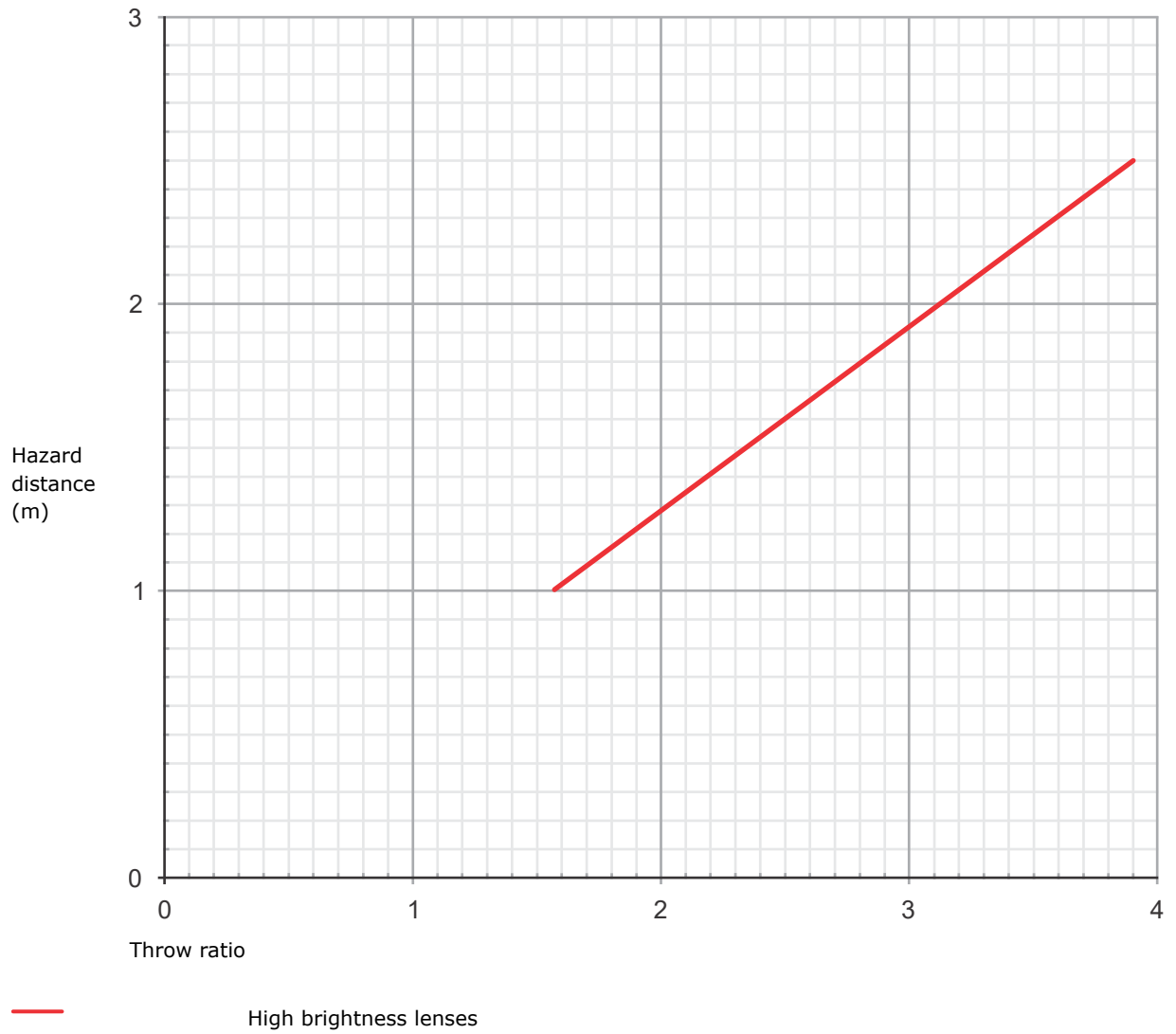

CP2411-RBe hazard distance graph

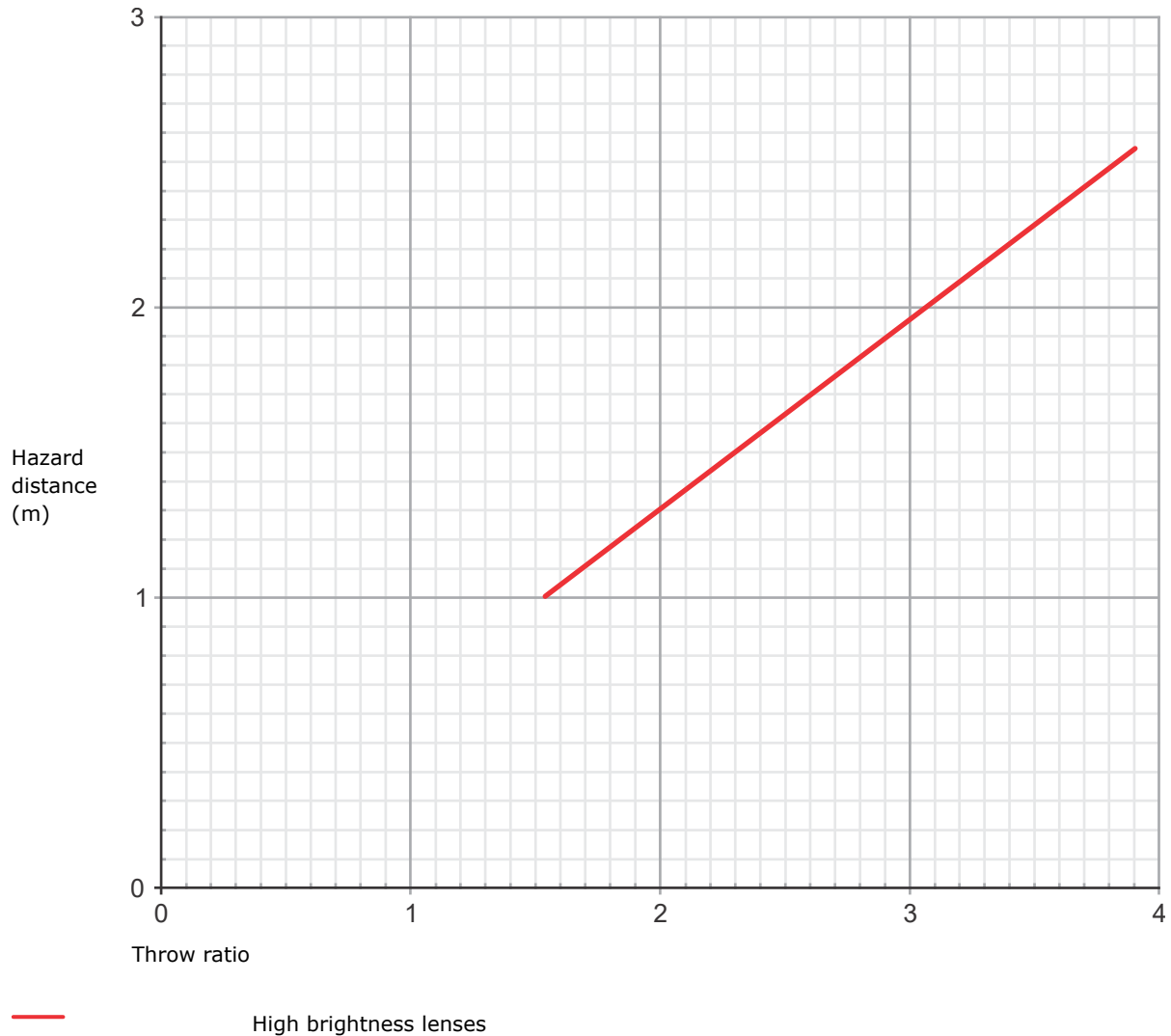

Stacking projectors

When two or more projectors are stacked (projecting on the same surface), due to the overlap of the images, a system hazard distance may need to be applied instead of a single projector hazard distance. When projectors are being stacked in two-dimension (for example 2x2), only projectors stacked along one axis (horizontal or vertical) should be considered, taking the stacking direction with the shortest lens distance (center-to-center distance) to reduce to separate two systems.

The following information is required is:

HD	Hazard distance of a single projector with the given lens (center-to-center distance)
h	Distance between two adjacent projector lenses in the stack

1. Determine the hazard distance (HD) of a single projector with a given lens and the distance (h) between the adjacent lenses.

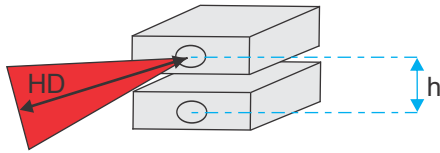

2. Determine the hazard distance for stacking two projectors:
 - If the single projector hazard distance is $HD \geq 9 \times h$, implement $1.15 \times HD$ for the hazard distance.
 - If the single projector hazard distance is $HD < 9 \times h$, keep the original hazard distance and risk zone as per the projector.

For Installations in the United States

The following must be in place for laser-illuminated projector installations in the United States:



- The projection room shall be clearly identified by the posting of laser warning and restricted access signs, and by restricting entry through physical means. The projection room sign must display the warning "No direct exposure to beam shall be permitted".
- The Christie Laser Projection System Installation Checklist must be fully completed after the installation and sent to lasercompliance@christiedigital.com. A copy can remain on-site. This checklist can be found as a separate document in the accessory box with the manual.
- Certain US states have additional laser regulatory requirements. Contact lasercompliance@christiedigital.com for additional regulatory requirements.

Product labels

Learn about the labels that may be used on the product. Labels on your product may be yellow or black and white.

General hazards

Hazard warnings also apply to accessories once they are installed in a Christie product connected to power.

Fire and Shock Hazard	
	<p>To prevent fire or shock hazards, do not expose this product to rain or moisture.</p> <p>Do not alter the power plug, overload the power outlet, or use it with extension cords.</p> <p>Do not remove the product enclosure.</p> <p>Only Christie qualified technicians are authorized to service the product.</p>
Electrical Hazard	
	<p>Risk of electric shock.</p> <p>Do not remove the product enclosure.</p> <p>Only Christie qualified technicians are authorized to service the product.</p>



Warning! If not avoided, the following could result in death or serious injury.



Electric shock hazard. To avoid personal injury, disconnect all power sources before performing maintenance or service.



Electrocution hazard. To avoid personal injury, always disconnect all power sources before performing maintenance or service procedures.



Optical radiation hazard. To avoid personal injury, never look directly at the light source.



Voltage hazard. To avoid personal injury, always disconnect all power sources before performing maintenance or service procedures.



Caution! If not avoided, the following could result in minor or moderate injury.



Hot surface hazard. To avoid personal injury, allow the product to cool for the recommended cool down time before touching or handling for maintenance or service.



Moving parts hazard. To avoid personal injury, keep hands clear and loose clothing tied back.



Moving fan blades. To avoid personal injury, keep hands clear and loose clothing tied back. Always disconnect all power sources before performing maintenance or service procedures.



Pinch hazard. To avoid personal injury, keep hands clear and loose clothing tied back.



Burn hazard. To avoid personal injury, allow the product to cool for the recommended cool down time before handling for maintenance or service.



Notice. If not avoided, the following could result in property damage.



General hazard.



Not for household use.

Mandatory actions



Caution! If not avoided, the following could result in minor or moderate injury.



Consult the service manual.



Disconnect all power sources before performing maintenance or service procedures.

Electrical labels



Indicates the presence of a protective earth ground.



Indicates the presence of an earth ground.

Laser hazards



FDA laser variance (US projectors only)

This product is in conformity with performance standards for laser products under 21 CFR 1040, except with respect to those characteristics authorized by Variance Number 2016-V-1838 effective on December 4, 2018.



CLASS 1 LASER PRODUCT IEC 60825-1:2014

Wavelengths: 449 nm - 661 nm

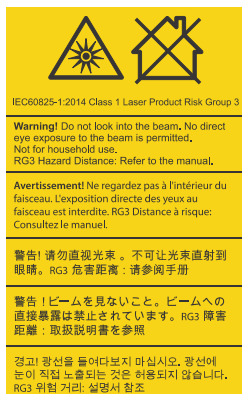

Indicates a light hazard. Do not look directly into the lens. The extreme high brightness can cause permanent eye damage.

Class 1 Laser Product - Risk Group 3 according to IEC 60825-1:2014 and IEC 62471-5:2015

Additional hazard labels



Indicates high leakage current. Earth or ground connection essential before connecting the power supply.

Indicates a light hazard. Do not look directly into the lens. The extreme high brightness can cause permanent eye damage.

Contact your dealer

Record the information about your installation and keep this information with your records to assist with any servicing of your product. If you encounter a problem, contact your dealer.

Purchase record
Dealer:
Dealer or Christie Sales/Service contact phone number:
Serial number: The serial number can be found on the license label.
Purchase date:
Installation date:

Key features

Understand the important features of the projector.

- Three-chip 0.69 inch CFB DC2K light engine
- Christie CineLife+™ electronics
- LiteLOC™ color lock feature for constant image brightness and color
- Direct-coupled laser module integrated in the projector chassis
- Compact form to fit in existing projection booths

List of components

Verify all components were received with the projector.

- High security key

Accessories

Learn about accessories that are available for the Cinema 2K-RBe projector.

Projection lenses

Projection lens	Part number
0.83-1.2:1 DLP Cine zoom	108-498102-XX
1.2-1.72:1 DLP Cine zoom	108-494108-XX
1.33-2.1:1 DLP Cine zoom	108-495109-XX
1.62-2.7:1 DLP Cine zoom	108-496100-XX
2.09-3.9:1 DLP Cine zoom	108-497101-XX

Filters

Description	Part Number
Card cage air filter—washable	003-004655-XX
Air filter 1	003-007541-XX
Air filter 2	003-007542-XX

UPS power cord (optional)

Description	Part Number
250 V/10 A C13 2.5 m—Australia	108-392105-XX
250 V/10 A C13 3.0 m—China	108-373104-XX
250 V/10 A C13 2.5 m—Europe	108-604101-XX
250 V/10 A C13 2.5 m—Europe and Korea	108-390103-XX
125 V/12 A C13 2.5 m—Japan	108-371102-XX
9.83 125 V/15 A black—North America	108-382104-XX
250 V/10 A C13L—South Africa	108-592107-XX
250 V/10 A C13L 3.1 m black—United Kingdom	108-589103-XX

Miscellaneous

Description	Part Number
Cover stacking cup	011-104349-XX
Locking stacking bracket	011-104470-XX
Rack stand	108-416102-XX
Extractor adapter	119-103105-XX

Description	Part Number
Touch panel	163-151108-XX

Technical support

Technical support for Christie Cinema products is available at:

- Support.cinema@christiedigital.com
- +1-877-334-4267
- Christie Professional Services: +1-800-550-3061 or NOC@christiedigital.com

Installing and setting up

Learn how to position and install the projector.

Site requirements

To safely install and operate the Cinema 2K-RBe projector, the installation location must meet these minimum requirements.

Physical operating environment

- Ambient temperature (operating) 10 to 35°C (50 to 95°F) up to 1000 m (3280.8 feet)
- Humidity (non-condensing) 10% to 80%
- Operating altitude 0 to 3000 meters (0 to 9843 feet) at 10 to 25°C (50 to 77°F)
In China, the operating altitude is 0 to 2000 meters (0 to 6562 feet)

External exhaust ducting

Sufficient ventilation is required around the projector to regulate the temperature of the internal laser module. If necessary, air intake and exhaust HVAC ducts can be installed.

An exhaust duct is also available for purchase as an optional accessory (P/N: 119-103105-XX). Instructions for installing the exhaust duct are included with the accessory part.

The installation site must provide an airflow 250 cubic feet per minute (CFM) at 1 to 1000 meters elevation, and must accommodate a heat load of 7166 BTU/hr.



For each additional 1000 meters above sea level, increase the airflow (CFM) value by 15%. If an extraction duct is not used, the operating temperature range is restricted to 10 to 25°C (50 to 77°F) at a maximum altitude of 3000 meters.

Permanent power connection

The projector light source requires the permanent AC connection to operate. There is also an available connector for an uninterruptible power supply (UPS) to provide backup power for the projector electronics only.

Certified wall breakers are required as part of the installation. Breakers must be part of the building and easily accessible. The size of the breaker is determined from the power requirements of the projector and can be up to 20A maximum for the main input and up to 10A maximum for the UPS input.

Power specifications

Learn the power requirements for the projector.

CP2406-RBe

Parameter	Mains	UPS
Rated voltage	200-240 VAC	100-240 VAC
Line frequency	50/60 Hz	50/60 Hz
Rated power	1200 W maximum	400 W maximum
Rated current	6 A, 1Φ	4 A, 1Φ

CP2409-RBe

Parameter	Mains	UPS
Rated voltage	200-240 VAC	100-240 VAC
Line frequency	50/60 Hz	50/60 Hz
Rated power	1500 W maximum	400 W maximum
Rated current	7.5 A, 1Φ	4 A, 1Φ

CP2411-RBe

Parameter	Mains	UPS
Rated voltage	200-240 VAC	100-240 VAC
Line frequency	50/60 Hz	50/60 Hz
Rated power	1800 W maximum	400 W maximum
Rated current	9 A, 1Φ	4 A, 1Φ

Projector components

Learn about the components on the front of the projector

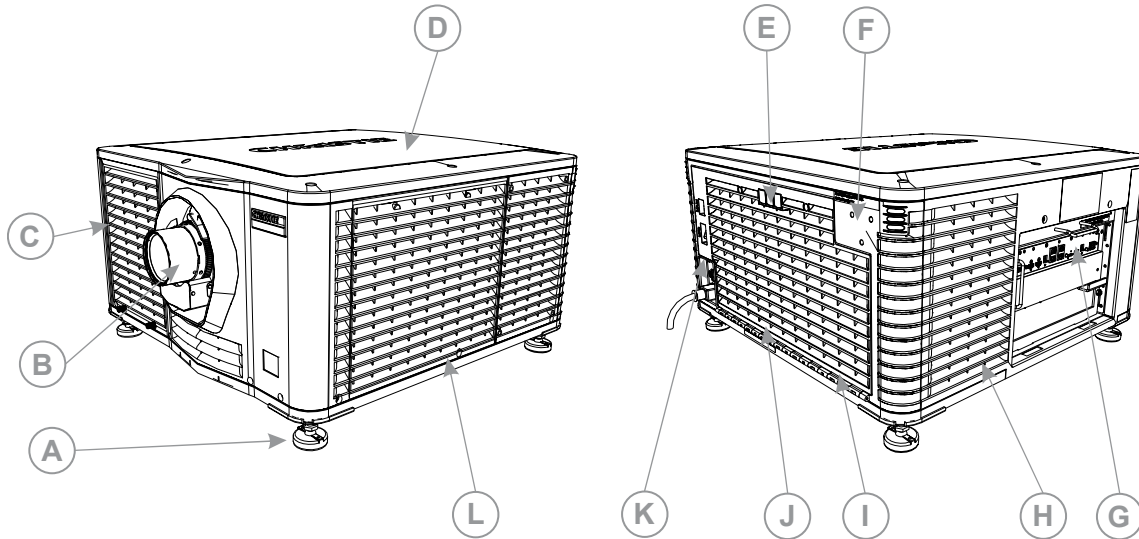

A	Adjustable feet—Turn the adjustable feet to increase or decrease the projector height
B	Projector lens
C	Air filter intake
D	Top cover
E	Status LED board
F	Touch panel mount location (optional)—A touch-sensitive screen used to control the projector
G	Card cage—Connect external devices and access the fire alarm interlock terminal
H	Air intake
I	Air intake
J	Air exhaust
K	AC receptacle, AC circuit breakers
L	Air exhaust

Preparing the installation site

Make sure the installation area is ready for the components.

1. Clear the installation area.
2. Post laser hazard warning signs at all entry doors.
3. Place each component near its installation location.

Lifting and positioning the projector

Safely lift and position the projector in the location where it will be used.



Warning! If not avoided, the following could result in death or serious injury.

- A minimum of four people or appropriately rated lift equipment is required to safely lift, install, or move the product.
- Do not install or operate the projector in any position that does not meet the stated product specifications for alignment and orientation.

This product must be installed in a landscape orientation, with all four feet supported on a level surface. Do not install or operate the projector in an inverted position. If your site has any installation requirements other than a typical theater projection booth, contact Christie for assistance.



Before lifting and positioning the projector, refer to the light intensity hazard distances.

1. Position each person at the corners of the projector.
2. Place both hands under the corner, grasping the projector frame.
Do not lift the projector using any feature on the projector cover, such as the cover louvers or lens opening.
3. Lift up the projector and move it to the location where it will be used.
4. Position the projector so it is centered and parallel with the theater screen.
If space is limited, aim the projector slightly off-center and use lens offset to center the image on the screen.

Connecting to an uninterruptable power supply

An uninterruptible power supply (UPS) allows the cinema projector head electronics to remain operable during a power failure.



Warning! If not avoided, the following could result in death or serious injury.

- SHOCK HAZARD! The AC power cord must be inserted into an outlet with grounding.
- SHOCK HAZARD! The optional UPS power cord must be inserted into an outlet with grounding.

The following table lists the part numbers for the optional UPS power cords for each region.

Description	Part Number
250 V/10 A C13 2.5 m–Australia	108-392105-XX
250 V/10 A C13 3.0 m–China	108-373104-XX
250 V/10 A C13 2.5 m–Europe	108-604101-XX
250 V/10 A C13 2.5 m–Europe and Korea	108-390103-XX
125 V/12 A C13 2.5 m–Japan	108-371102-XX
9.83 125 V/15 A black–North America	108-382104-XX
250 V/10 A C13L–South Africa	108-592107-XX
250 V/10 A C13L 3.1 m black–United Kingdom	108-589103-XX

1. Switch the AC inline for 12V power supply from the MAIN inline to the UPS inline.
2. Connect the line cord to the MAIN input.
3. Connect another line cord to the UPS input.
4. To turn on the projector, move the MAIN breaker switch to the on position and then move the UPS breaker switch to the on position.

If you do not want to connect to an uninterruptable power supply, connect the 12V AC inline to the MAIN line, connect the appropriate line cord to the Main input, and only move the MAIN breaker switch to the on position.

Installing the lens

The lens seals the projection head, preventing contaminants from entering the main electronics area.



Notice. If not avoided, the following could result in property damage.

- Do not operate the product without a lens installed.
 - Always use a lens plug when installing or moving the product. This prevents contaminants from entering the product.
 - Do not insert the lens into the product at an angle. This can damage the lens and the optical components inside the product.
 - Always place the lens cap onto the lens when moving the projector to avoid scratching the lens.
 - Remove the lens cap before turning on the product to avoid damaging the lens.
1. Before installing the lens, make sure you turn off and unplug the projector.
 2. Remove the lens surround.
 3. Turn the lens clamp on the front of the projector to the open position.
The lens clamp can be turned manually but Christie recommends using a hex key to turn it to the correct position.

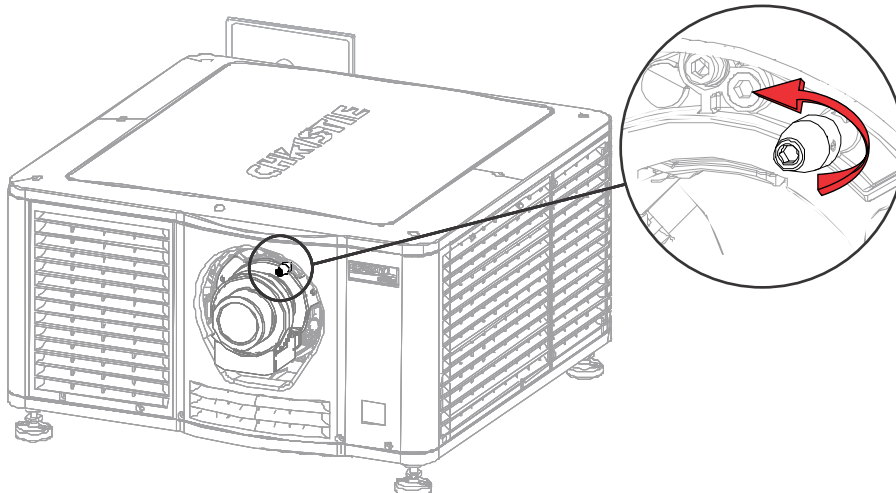

4. Position the lens so the lens retaining ring mounts align with the lens mount.
5. Remove the lens caps from the front and rear of the lens.



Lens caps must be removed or they can melt and damage the lens.

6. Insert the lens straight into the lens mount opening without turning. Magnets inside the lens mount help position the lens.
7. Insert and tighten the two lens mount hex screws shipped separately with the projector.

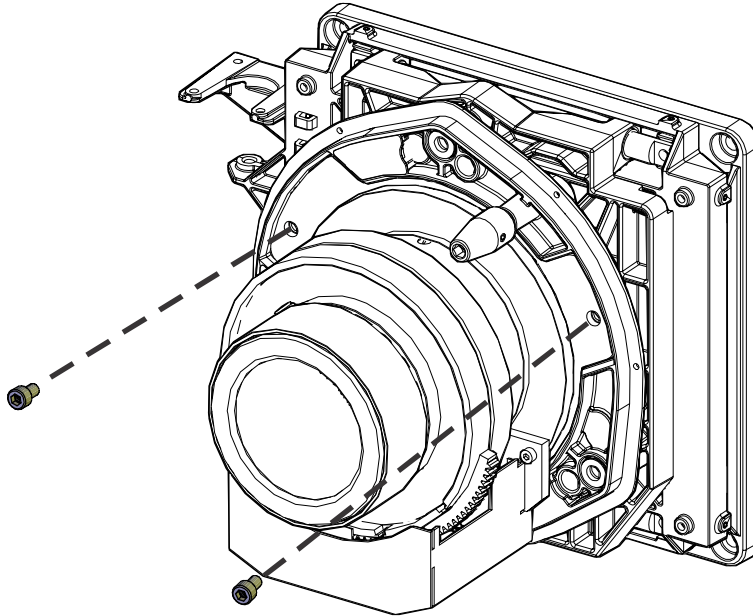

8. Lock the lens assembly in place. The lens clamp can be turned manually but Christie recommends using a hex key to turn it to the correct position.

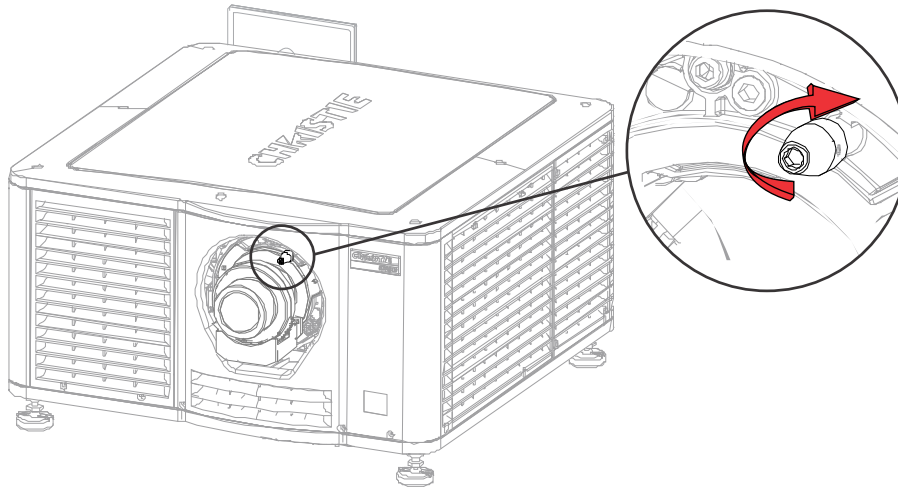

9. Replace the lens surround.

Installing the touch panel (optional)

Learn how to install the optional touch panel control (TPC) and connect the required harnesses for communication with the projector.

1. To secure the ball arm, fasten with the four screws.
Torque to 20in-lb.
2. Install the TPC arm onto the ball arm.
3. Install the touch screen monitor onto the TPC arm.
4. Connect the touch screen monitor communication harness to the USB-C port on the Video Input panel.

Projector power modes

The Cinema 2K-RBe projectors track laser operation hours for the laser optical subsystem (LOS).

The projector operates with the following power modes:

Mode	Description
Projector on	<ul style="list-style-type: none"> • CineLife+ electronics and light engine are on • Laser optical subsystem (LOS) is off • Integrated Media Block (IMB) is on
Light source on	<ul style="list-style-type: none"> • CineLife+ electronics and light engine are on • LOS is on • Fans run at full speed • IMB is on
Standby	<ul style="list-style-type: none"> • CineLife+ electronics remain on standby with the light engine off • Fans and LOS are off • IMB is off—IMB automation does not function
Hibernate	<ul style="list-style-type: none"> • Ethernet PHY for Wake On LAN (WOL) magic packet and Hibernate Interface switch powered and enabled • Other parts of the projector are off
IMB powered in Standby	<ul style="list-style-type: none"> • Turns on the IMB • Increases the air flow inside the projector to cool the card cage electronics

Using the web user interface (Web UI)

Use a web browser to use the web UI to access projector functionality.

1. Log into the Web UI.
The default IP address is 192.168.206.110.

2. To access the projector menu, select the left navigation menu.
3. To upload or download files from the projector, navigate to the feature.
4. If the projector has a GDC IMB SR-1000 installed and configured, access the GDC IMB Web UI by navigating to the menu and selecting **IMB**.

Turning on or off the projector

Turn on the projector to display content or turn off the projector to conserve energy or service the projector.

1. Determine if you are using an *uninterruptable power supply* (on page 22).
2. Plug the projector into AC power.
3. Turn on the breaker switch(es).
 - If connected to an uninterruptable power supply, move the MAIN breaker switch to the on position and then move the UPS breaker switch to the on position.
 - If not connected to an uninterruptable power supply, only move the MAIN breaker switch to the on position.
4. In the right toolbar, select and hold **Power**. 

If the light source is on when turning off the projector, the light source automatically enters a three-minute cool-down period.

Logging into the projector

Log into the projector to access projector menus.

1. Select **Login**.
If using the Web UI, you do not need to select **Login**.
2. In the User list, select a username.
3. Enter your password.
4. Select **Login**.

Turning on or off the light source

Turn on the light source to display content or view test patterns. Turn off the light to extend the life of the light source.

- To turn on or off the light source, in the right toolbar, select and hold **Light**. 

If turning on the light source when the projector power is off, power is turned on automatically. Allow the projector to cool down for three minutes after turning it off.

Selecting Integrated Media Block (IMB) preferences

Choose from the available options to set the type of Integrated Media Block (IMB).

1. In the left navigation menu, select **Service Setup** > **Preferences**.
2. Select **IMB**.
3. In the Type list, select **Christie** from the available IMB models.
4. When the system prompts you to reboot the projector, select **Reboot**.
5. After the projector has restarted, log in with your user account.

Activating marriage

After selecting the Integrated Media Block (IMB) type, you must install the IMB and complete marriage to display secure content and to comply with the Digital Cinema Initiatives (DCI) specification. You cannot complete marriage remotely.

For more information on marriage, refer to *CineLife+ 2.0 User Guide (P/N: 020-103845-XX)*.

You cannot complete marriage remotely because you must select the **Marriage** button on the input panel during the marriage process.

1. Verify the marriage ring is installed correctly and an anti-tamper alarm does not appear on the touch panel.
2. In the left navigation menu, select **Service Setup** > **Marriage Setup**.
3. Select **Start** and complete the Marriage Setup wizard.
At the Arming stage, enter the Marriage password.
4. Select **Finish**.

Disposing of the product packaging

Once the product has been installed and set up, Christie recommends reusing or recycling the product packaging according to your local regulations.

Completing the installation checklist

Complete the provided installation checklist (P/N: 020-103137-XX) and return it to Christie.

Video Input panel

The Video Input panel, located on the projector side input panel (operator side), has a variety of ports that can supply alternative video content to the projector.

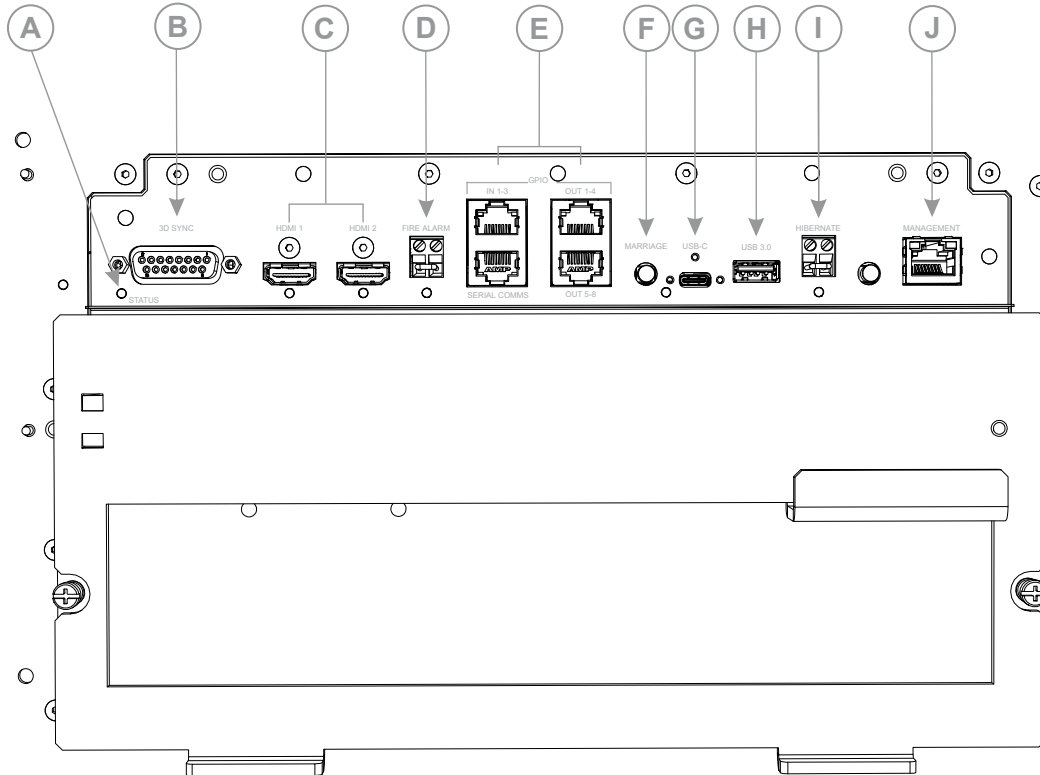

ID	Port	Description
A	Status	Provides a status indicator for the projector.
B	3D sync connector	Connects the projector to 3D devices.
C	HDMI input 1 and HDMI input 2	Type A connector Accepts digital video data from HDMI v2.0 input supporting EDID 1.3 with HDCP v1.4 and 2.2 support.
D	Fire alarm connection	Connects to the Theater Fire Management system for automatic shut down in emergency situations.
E	GPIO port	Connects the projector to external automation or automation devices.
F	Marriage button	Used during the Integrated Media Block (IMB) marriage setup process.

ID	Port	Description
		<ul style="list-style-type: none"> • Select and hold the button for 5 seconds to display the IP address and status information. • Select and hold the button for 30 seconds to reset the IP address to the default address of 192.168.206.110. <p>The marriage status LED indicator is located to the right of the Marriage button. In full power mode, a green LED indicates the projector is properly married and encrypted content can be displayed. A red LED indicates marriage is broken and encrypted content cannot be displayed.</p>
G	USB-C port	Connects the projector touch panel.
H	USB port	Connects to external memory device for import and export of projector software, configuration files, and status information.
I	Hibernate	Brings the projector out of Hibernate mode.
J	Management port	Connects to the local network and can send CineLife+ serial commands and used for Web UI access.

HDMI video source

For the projector to accept digital video data from HDMI sources, plug the HDMI source directly into the Video Input panel.

The input configurations listed below are supported.

Input configuration	Description
Single-input	Accepts connection of one HDMI cable. Supports both 2D and 3D frame-packed, top and bottom. In this configuration, the HDMI input supplies the entire video raster.
Dual-input	Enables connection of two HDMI cables in support of 3D LR, where HDMI Input 1 = left eye and HDMI Input 2 = right eye.

HDMI video formats

The following image formats are supported by the two HDMI inputs.



Fractional 1/1.001 frame rates, 1920 x 1080 (HD), and 3840 x 2160 (UHD) formats are also supported.

Single-input 2D 2K and 4K HDMI 2.0 image formats

Each HDMI input supports the following single-input (one cable) 2D 2K and 4K HDMI 2.0 image formats.

	Format	Cables	Frame rate (Hz)	Sampling	Bit-depth
2K	2048x1080	1	24, 25, 30, 50, 60, 120	Y'C _B C _R /RGB/4:4:4 Y'C _B C _R /4:2:2	8/10/12 bpc
4K	4096x2160	1	24, 25, 30	Y'C _B C _R /RGB/4:4:4	8/10/12 bpc

Format	Cables	Frame rate (Hz)	Sampling	Bit-depth
			Y'C _B C _R /4:2:2	
4096x2160	1	50, 60	Y'C _B C _R /RGB/4:4:4	8 bpc
4096x2160	1	50, 60	Y'C _B C _R /4:2:2	8/10/12 bpc

Single-input 2D HD HDMI 2.0 image formats

Each HDMI input supports the following single-input (one cable) 2D HD HDMI 2.0 image formats.

Format	Cables	Frame rate (Hz)	Sampling	Bit-depth	Notes
HD	1280x720	1	24, 25, 30, 50, 60	Y'C _B C _R /RGB/4:4:4 Y'C _B C _R /4:2:2	8/10/12 bpc -
	1920x1080i	1	25, 30	Y'C _B C _R /RGB/4:4:4 Y'C _B C _R /4:2:2	8/10/12 bpc 2048x1080 interlaced (50/60 Hz field rate)

Single-input 2D HDMI 2.0 PC image formats

Each HDMI input supports the following single-input 2D HDMI 2.0 PC image formats.

Format	Cables	Frame rate (Hz)	Sampling	Bit-depth	
PC	1280x800	1	60	RGB	8 bpc
	1280x960	1	60	RGB	8 bpc
	1280x1024	1	60	RGB	8 bpc
	1440x900	1	60	RGB	8 bpc
	1680x1050	1	60	RGB	8 bpc
	1600x1200	1	60	RGB	8 bpc
	2048x1200	1	60	RGB	8 bpc

Single-input 3D 2K/HD HDMI 2.0 image formats

Each HDMI input supports the following single-input (one cable) 3D 2K/HD HDMI 2.0 image formats.

Format	Cables	Frame rate (Hz)	Sampling	Bit-depth	Notes
3D	1280x720	1	50, 60	Y'C _B C _R /RGB/4:4:4 Y'C _B C _R /4:2:2	8/10/12 bpc Frame-packing/top-and-bottom
	2048x1080	1	24, 25, 30, 50, 60	Y'C _B C _R /RGB/4:4:4 Y'C _B C _R /4:2:2	8/10/12 bpc Frame-packing

Dual-input 3D 2K/4K HDMI 2.0 image formats

The following dual-input 3D 2K/4K HDMI 2.0 image formats are supported, where HDMI Input 1 = left eye and HDMI Input 2 = right eye. Frame rate is expressed per eye in the following table.

	Format	Cables	Frame rate (Hz)	Sampling	Bit-depth
2K	2048x1080	2	24, 25, 30, 50, 60	Y'C _B C _R /RGB/4:4:4 Y'C _B C _R /4:2:2	8/10/12 bpc
4K	4096x2160	2	24, 25, 30	Y'C _B C _R /RGB/4:4:4 Y'C _B C _R /4:2:2	8/10/12 bpc
	4096x2160	2	50, 60	Y'C _B C _R /RGB/4:4:4	8 bpc
	4096x2160	2	50, 60	Y'C _B C _R /4:2:2	8/10/12 bpc

Integrated Media Block (IMB) video source

Christie Series 4 projectors support both the legacy Series 2 (S2) and newer Series 4 (S4) HDRConnect™ IMB interfaces to send digital video data from an IMB to the projector.

Contact Christie Technical Support to learn which S2 and S4 IMB devices are compatible with Christie projectors.

Series 2 Integrated Media Block (IMB) video formats

S2 Integrated Media Block (IMB) video format support is determined by the IMB make and model. Refer to the associated IMB documentation to understand which of the following video signals are supported.

All MPEG-2 content is converted in the media block to RGB 4:4:4 8-bit before play out.

MPEG image formats

Format	Resolution	Max frame rate 2D	Max frame rate 3D	Min frame rate	Bit-depth
VGA	640x480	120.0	120.0	23.0	8-bits
4CIF	704x576	120.0	120.0	23.0	8-bits
525 SD	720x480	120.0	120.0	23.0	8-bits
625 SD	720x568	120.0	120.0	23.0	8-bits
XGA	1024x768	79.6	79.6	23.0	8-bits
720p HD	1280x720	68.0	68.0	23.0	8-bits
4VGA	1280x960	51.0	51.0	23.0	8-bits
SXGA	1280x1024	47.8	N/A	23.0	8-bits
525 16SIF	1408x960	46.3	N/A	23.0	8-bits
16CIF	1408x1152	38.6	N/A	23.0	8-bits
4SVGA	1600x1200	32.6	N/A	23.0	8-bits

Format	Resolution	Max frame rate 2D	Max frame rate 3D	Min frame rate	Bit-depth
1080 HD	2048x1080	30.0	N/A	23.0	8-bits

MPEG-2 MXF interop 2D image formats

Format	Resolution	Max frame rate 2D	Max frame rate 3D	Min frame rate	Bit-depth
VGA	640x480	120.0	120.0	23.0	8-bits
525 4SIF	704x480	120.0	120.0	23.0	8-bits
525 SD	720x480	120.0	120.0	23.0	8-bits
4CIF	704x576	120.0	120.0	23.0	8-bits
625 SD	800x600	120.0	120.0	23.0	8-bits
SVGA	1024x768	79.6	79.6	23.0	8-bits
XGA	1024x768	79.6	79.6	23.0	8-bits
720p HD	1280x720	68.0	68.0	23.0	8-bits
4VGA	1280x960	51.0	51.0	23.0	8-bits
SXGA	1280x1024	47.8	N/A	23.0	8-bits
525 16SIF	1408x960	46.3	N/A	23.0	8-bits
16CIF	1408x1152	38.6	N/A	23.0	8-bits
4SVGA	1600x1200	32.6	N/A	23.0	8-bits
1080 HD	2048x1080	30.0	N/A	23.0	8-bits

SMPTE-compatible 2D (JPEG 2000) cinema image formats

Specification	Resolution	Frame rate	Color format	Bit-depth
SMPTE 428-1-2019	2048x1080	24.0	X'Y'Z' (4:4:4)	12-bits
SMPTE 428-11-2013	2048x1080	25.0	X'Y'Z' (4:4:4)	12-bits
SMPTE 428-11-2013	2048x1080	30.0	X'Y'Z' (4:4:4)	12-bits
SMPTE 428-1-2019	2048x1080	48.0	X'Y'Z' (4:4:4)	12-bits
SMPTE 428-11-2013	2048x1080	50.0	X'Y'Z' (4:4:4)	12-bits
SMPTE 428-11-2013	2048x1080	60.0	X'Y'Z' (4:4:4)	12-bits
SMPTE 428-1-2019	4096x2160	24.0	X'Y'Z' (4:4:4)	12-bits
SMPTE 428-11-2013	4096x2160	25.0	X'Y'Z' (4:4:4)	12-bits
SMPTE 428-11-2013	4096x2160	30.0	X'Y'Z' (4:4:4)	12-bits

SMPTTE-compatible 3D (JPEG 2000) cinema image formats

Specification	Resolution	Frame rate (per eye)	Color format	Bit-depth
SMPTE 428-1-2019	2048x1080	24.0x2	X'Y'Z' (4:4:4)	12-bits
SMPTE 428-1-2019	2048x1080	48.0x2	X'Y'Z' (4:4:4)	12-bits
SMPTE 428-11-2013	2048x1080	60.0x2	X'Y'Z' (4:4:4)	12-bits

Series 4 Integrated Media Block (IMB) video formats

S4 Integrated Media Block (IMB) video format support is determined by the IMB make and model. Refer to the associated IMB documentation to understand which of the following video signals are supported.

All MPEG-2 content is converted in the media block to RGB 4:4:4 8-bit before play out.

MPEG image formats

Format	Resolution	Max frame rate 2D	Max frame rate 3D	Min frame rate	Bit depth
VGA	640x480	120.0	120.0	23.0	8-bits
525 4SIF	704x480	120.0	120.0	23.0	8-bits
525 SD	720x480	120.0	120.0	23.0	8-bits
4CIF	704x576	120.0	120.0	23.0	8-bits
625 SD	800x600	120.0	120.0	23.0	8-bits
SVGA	1024x768	79.6	79.6	23.0	8-bits
XGA	1024x768	79.6	79.6	23.0	8-bits
720p HD	1280x720	68.0	68.0	23.0	8-bits
4VGA	1280x960	51.0	51.0	23.0	8-bits
SXGA	1280x1024	47.8	N/A	23.0	8-bits
525 16SIF	1408x960	46.3	N/A	23.0	8-bits
16CIF	1408x1152	38.6	N/A	23.0	8-bits
4SVGA	1600x1200	32.6	N/A	23.0	8-bits
1080 HD	2048x1080	30.0	N/A	23.0	8-bits

MPEG-2 MXF interop 2D image formats

Format	Resolution	Max frame rate 2D	Max frame rate 3D	Min frame rate	Bit depth
VGA	640x480	120.0	120.0	23.0	8-bits
525 4SIF	704x480	120.0	120.0	23.0	8-bits

Format	Resolution	Max frame rate 2D	Max frame rate 3D	Min frame rate	Bit depth
525 SD	720x480	120.0	120.0	23.0	8-bits
625 SD	720x568	120.0	120.0	23.0	8-bits
4CIF	704x576	120.0	120.0	23.0	8-bits
XGA	1024x768	79.6	79.6	23.0	8-bits
720p HD	1280x720	68.0	68.0	23.0	8-bits
4VGA	1280x960	51.0	51.0	23.0	8-bits
SXGA	1280x1024	47.8	N/A	23.0	8-bits
525 16SIF	1408x960	46.3	N/A	23.0	8-bits
16CIF	1408x1152	38.6	N/A	23.0	8-bits
4SVGA	1600x1200	32.6	N/A	23.0	8-bits
1080 HD	2048x1080	30.0	N/A	23.0	8-bits

SMPTÉ-compatible 2D (JPEG 2000) cinema image formats

Specification	Resolution	Frame rate	Color format	Bit depth
SMPTÉ 428-1-2019	2048x1080	24.0	X'Y'Z' (4:4:4)	12-bits
SMPTÉ 428-11-2013	2048x1080	25.0	X'Y'Z' (4:4:4)	12-bits
SMPTÉ 428-11-2013	2048x1080	30.0	X'Y'Z' (4:4:4)	12-bits
SMPTÉ 428-1-2019	2048x1080	48.0	X'Y'Z' (4:4:4)	12-bits
SMPTÉ 428-11-2013	2048x1080	50.0	X'Y'Z' (4:4:4)	12-bits
SMPTÉ 428-11-2013	2048x1080	60.0	X'Y'Z' (4:4:4)	12-bits
SMPTÉ 428-11-2013	2048x1080	96.0	X'Y'Z' (4:4:4)	12-bits
SMPTÉ 428-11-2013	2048x1080	100.0	X'Y'Z' (4:4:4)	12-bits
SMPTÉ 428-11-2013	2048x1080	120.00	X'Y'Z' (4:4:4)	12-bits
SMPTÉ 428-1-2019	4096x2160	24.0	X'Y'Z' (4:4:4)	12-bits
SMPTÉ 428-11-2013	4096x2160	25.0	X'Y'Z' (4:4:4)	12-bits
SMPTÉ 428-11-2013	4096x2160	30.0	X'Y'Z' (4:4:4)	12-bits
SMPTÉ 2048-1-2011 Am1:2016	4096x2160	48	X'Y'Z' (4:4:4)	12-bits
SMPTÉ 2048-1-2011 Am1:2016	4096x2160	50	X'Y'Z' (4:4:4)	12-bits
SMPTÉ 2048-1-2011 Am1:2016	4096x2160	60	X'Y'Z' (4:4:4)	12-bits
SMPTÉ 2048-1-2011 Am1:2016	4096x2160	96	X'Y'Z' (4:4:4)	12-bits

Specification	Resolution	Frame rate	Color format	Bit depth
SMPTE 2048-1-2011 Am1:2016	4096x2160	100	X'Y'Z' (4:4:4)	12-bits
SMPTE 2048-1-2011 Am1:2016	4096x2160	120	X'Y'Z' (4:4:4)	12-bits

SMPTE-compatible 3D (JPEG 2000) cinema image formats

Specification	Resolution	Frame rate (per eye)	Color format	Bit depth
SMPTE 428-1-2019	2048x1080	24.0x2	X'Y'Z' (4:4:4)	12-bits
SMPTE 428-11-2013	2048x1080	25.0x2	X'Y'Z' (4:4:4)	12-bits
SMPTE 428-11-2013	2048x1080	30.0x2	X'Y'Z' (4:4:4)	12-bits
SMPTE 428-1-2019	2048x1080	48.0x2	X'Y'Z' (4:4:4)	12-bits
SMPTE 428-11-2013	2048x1080	50.0x2	X'Y'Z' (4:4:4)	12-bits
SMPTE 428-11-2013	2048x1080	60.0x2	X'Y'Z' (4:4:4)	12-bits
SMPTE 428-1-2019	4096x2160	24.0x2	X'Y'Z' (4:4:4)	12-bits
SMPTE 428-11-2013	4096x2160	25.0x2	X'Y'Z' (4:4:4)	12-bits
SMPTE 428-11-2013	4096x2160	30.0x2	X'Y'Z' (4:4:4)	12-bits
SMPTE 2048-1-2011 Am1:2016	4096x2160	48.0x2	X'Y'Z' (4:4:4)	12-bits
SMPTE 2048-1-2011 Am1:2016	4096x2160	50.0x2	X'Y'Z' (4:4:4)	12-bits
SMPTE 2048-1-2011 Am1:2016	4096x2160	60.0x2	X'Y'Z' (4:4:4)	12-bits

HDMI video source connection from an Integrated Media Block (IMB)

The projector can accept digital video data from HDMI sources connected to applicable Integrated Media Block (IMB) devices. The input configurations supported are determined by the IMB device directly.

Contact Christie Technical Support to learn which IMB devices provide HDMI source selection from the projector user interface.

HDMI input selection directly from the IMB may also be possible using the IMB user interface. The input configurations supported are determined by the IMB make and model.

SDI video source connection from an Integrated Media Block (IMB)

The projector can accept digital video data from SDI sources connected to applicable Integrated Media Block (IMB) devices.

The input configurations supported are determined by the IMB device directly. Contact Christie Technical Support to learn which IMB devices provide SDI source selection from the projector user interface.

SDI input selection directly from the IMB may also be possible using the IMB user interface. The input configurations supported are determined by the IMB make and model.

GPIO connector

The Generic Purpose Input Output (GPIO) connectors provide a flexible method of interfacing with the projector. There are three GPIO connectors with one connector reserved for serial communications.

The GPIO connectors are located on the input panel (*E in the Video Input panel image (on page 28)*).

Left-side GPI pins

The top six GPI pins are available for inputs with the other two pins reserved for ground and power. The bottom pins are reserved for serial communications.

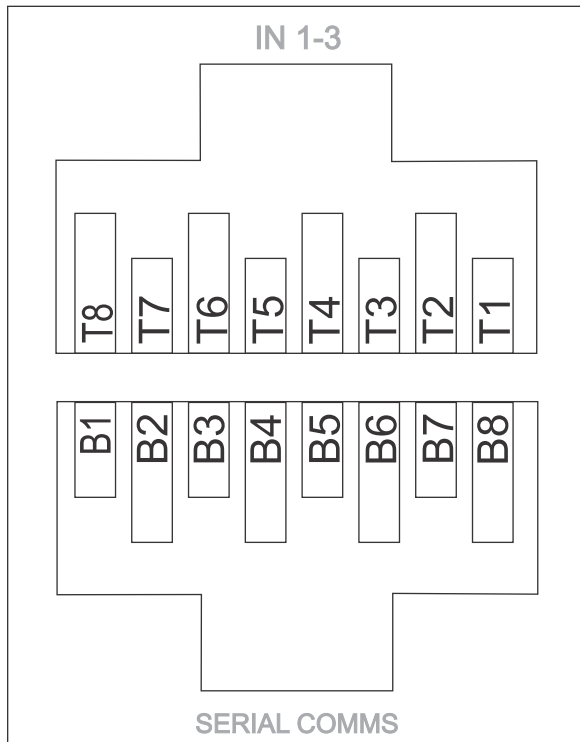

Pin number	Signal name	Direction
T1	+5V	—

Pin number	Signal name	Direction
T2	GND	—
T3	GPI1_POS	In
T4	GPI1_NEG	In
T5	GPI2_POS	In
T6	GPI2_NEG	In
T7	GPI3_POS	In
T8	GPI3_NEG	In
B1	Serial Communications	—
B2		
B3		
B4		
B5		
B6		
B7		
B8		

Right-side GPO pins

The 16 pins are available for output.

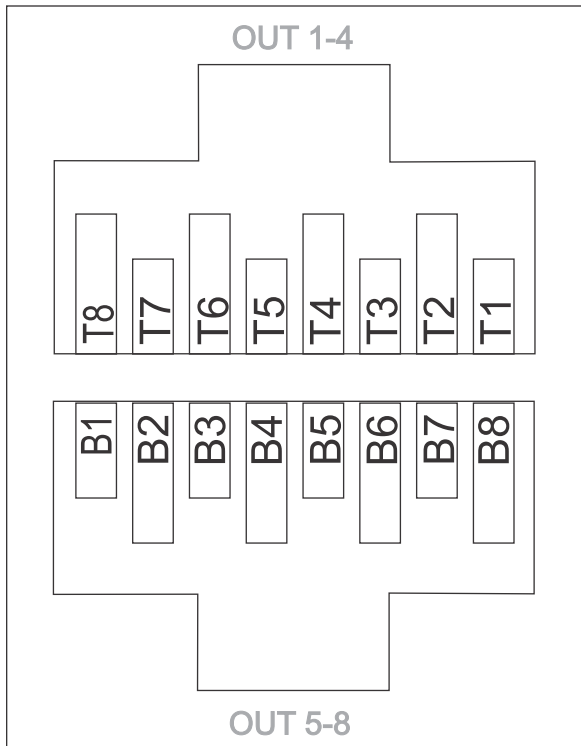

Pin number	Signal name	Direction
T1	GPO1_SRC	Out
T2	GPO1_RTN	Out
T3	GPO2_SRC	Out
T4	GPO2_RTN	Out
T5	GPO3_SRC	Out
T6	GPO3_RTN	Out
T7	GPO4_SRC	Out
T8	GPO4_RTN	Out
B1	GPO5_SRC	Out
B2	GPO5_RTN	Out
B3	GPO6_SRC	Out
B4	GPO6_RTN	Out
B5	GPO7_SRC	Out
B6	GPO7_RTN	Out
B7	Health_SRC	Out
B8	Health_RTN	Out

GPIO inputs

The 5 VDC (pin T1 and pin T2 in the left-hand GPI) is intended for use to supply the inputs.

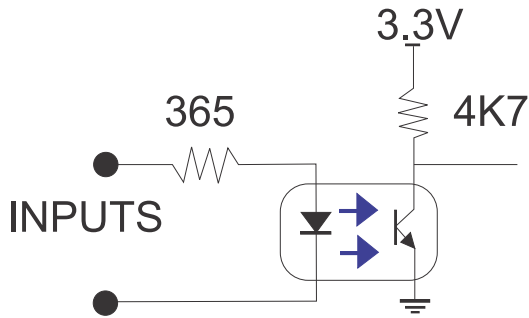

GPIO outputs

Outputs are solid state relays with a 1 A AC/DC rating at up to 48 V.

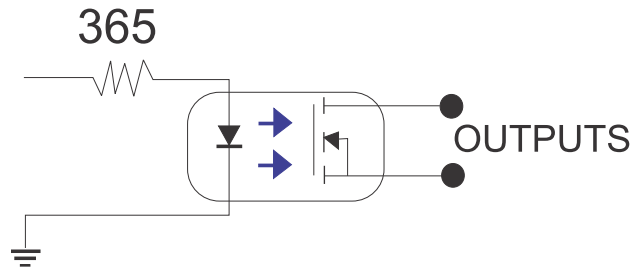

Managing the light source

Learn how to configure a laser file and use the projector's LiteLOC™ feature.

Use the laser file to control the power settings of the red, green, and blue (RGB) lasers. The LiteLOC™ feature ensures that color and brightness are held at the level you set.

Create multiple laser files to manage varying screen sizes, brightness requirements, room temperatures in the projection booth, and types of content (such as 2D, 3D, and alternative content).

Creating a new laser file

Create a laser file to store the power settings for the RGB laser light source and the maximum expected room temperature for the projection booth.

To make sure color and brightness are held at the required levels for your installation, enable LiteLOC for each laser file you create. If you make significant change to the brightness level when refining the laser power settings, it takes a few minutes for the color and brightness to stabilize.

1. Log in as service.
2. Turn on the laser.
3. For systems upgraded to v1.5.0 and already using the calibration file, set a channel to use the appropriate calibration file and activate the channel.
For details on setting up and activating the channel, refer to the *CineLife+ 2.0 User Guide* (P/N: 020-103845-XX).
4. Set up the color meter to aim at the center of the screen.
5. In the left navigation menu, select **Laser Settings > Laser Power/LiteLOC Setup**.
6. Select **Display White Test Pattern**.
7. To create a new laser file, select **Create**. 
8. In the Create dialog, enter a name for the new laser file and select **Create**.
9. In the White Coordinates dialog, set the required white point.
For a typical cinema setup, the white point is Digital Cinema Initiative (DCI) white $x=0.314$ and $y=0.351$.
10. Select **Apply**.
11. Adjust the brightness level until you achieve the required brightness at the specified white point.
12. If the laser file will be associated with a 3D channel, complete the following steps:
 - a) Engage the 3D system in the light path by enabling **3D Sync** when selecting the test pattern.
 - b) Mount a 3D glass or filter on the color meter to measure the brightness.

- c) Select **3D Sync** on the LiteLOC setup page.
- d) Adjust the brightness level until you achieve the required brightness while the 3D system is engaged.

13. To save the new laser file, select **Save**. 

Modifying an existing laser file

Modify the settings in the laser file to change the laser power settings or the maximum expected room temperature.

When refining the laser power settings, the amount of time required to re-stabilize the projector depends on the size of the adjustment. For small adjustments to the expected room temperature or power settings, the projector requires only 1 or 2 minutes to re-stabilize. For larger adjustments, the projector may require up to 15 minutes to re-stabilize.

1. In the left navigation pane, select **Laser Settings > Laser Power/LiteLOC Setup**.
2. From the Laser File list, select the laser file to edit.
3. Select the **Display White Test Pattern**, if required.
4. Adjust the brightness slider as required.
5. To change the white point, select White coordinates box, modify the coordinates, and select **Apply**.
Selecting **Default** returns it to the Digital Cinema Initiative (DCI) white point.
6. Once the correct brightness is achieved and the projector has stabilized, to save the new settings select **Save** .

Copying existing laser settings to a new file

Copy an existing laser file when you want to create a new file with similar settings.

1. In the left navigation pane, select **Laser Settings > Laser Power/LiteLOC Setup**.
2. From the Laser File list, select the file you want to copy.
3. To save the new laser file, select **Save As** .
4. Enter a new name for the laser file and select **Save**.
5. Adjust the brightness and white settings as required for the new configuration.

Deleting a laser file

Delete a laser file when the configuration is no longer required.

1. In the left navigation menu, select **Laser Settings > Laser Power/LiteLOC Setup**.
2. In the Laser File list, select the file to delete.
3. Select **Delete** .
4. To confirm the deletion, select **Delete**.

LiteLOC™ sensor-to-screen calibration

The LiteLOC™ sensor-to-screen calibration is performed in the factory under specific setup conditions which include the type of lens, screen, and the spectroradiometer used for measuring screen color and brightness.

Your projector's setup conditions may not match the factory setup which may result in a discrepancy in color accuracy. Upon first installation, check the accuracy of the color point and if unsatisfactory, perform this calibration. Doing this calibration captures all the variables of your setup and achieves the best results. By doing this calibration, you do not overwrite the factory calibration. Once satisfied, some scenarios may exist in which you may need to re-do the calibration in the future.

Re-doing this calibration is required if the following is replaced:

- Color sensor board

Christie recommends re-doing this calibration if any of the following are replaced:

- Light engine
- Lens
- Light source
- Screen
- Port window
- Any other optical components in the optical path between the light source and the screen

After replacing these components, check the accuracy of the color point and if unsatisfactory, re-do this calibration.

LiteLOC™ sensor-to-screen calibration: Workflow

Identify the recommended order for performing the sensor-to-screen calibration.



LiteLOC™ sensor-to-screen calibration requires the following:

- Spectroradiometer
- Service user is the minimum level user access
- *Create a new calibration file* (on page 42).
- *Recalibrate the calibration file* (on page 44), if required.
- *Edit the existing calibration file parameters* (on page 45) on the Sensor-to-screen menu, if required.
- *Verify the calibration* (on page 45), if required.
- *Add the calibration file to the Channel Setup* (on page 46).

Creating a new calibration file

The Sensor-to-screen Calibration wizard guides you through the steps required to create a new calibration file.

1. Set up a spectroradiometer to obtain screen measurements later in the process.
2. In the left navigation menu, select **Color Settings > Sensor-to-screen Calibration**.

3. To create a new calibration file, select **Create** .

The projector checks if the light source is on and the douser is open. If either condition is not met, a warning dialog is displayed prompting you to make sure these conditions are met before starting the wizard.

4. In the Create dialog, enter a name for the new calibration file and select **Create**.
5. In step 1 of the Sensor-to-screen Calibration wizard, set the maximum brightness and color point.
 - a) Enable the **Display White Test Pattern** option.
 - b) To set the maximum expected room and chiller (for chiller-based products) temperatures, use the plus (+) or minus (-) signs.
 - c) Adjust the RGB sliders to set the brightness and color point.
 - d) Select **Next**.

6. Wait 20 minutes for the projector to stabilize or select **Skip** during the stabilization time period.

7. In step 2 of the Sensor-to-screen Calibration wizard, measure and enter the screen values.

- a) To trigger the measurement at a specific operating point, under Sensor to screen, select **Capture**.

The Capture button changes color to indicate the capture process is activated. Only one Capture button is active at a time but the buttons can be selected in any order.

The projector automatically sets the red, green, and blue output laser powers to the pre-determined settings calculated and displayed in the Drive Percentage (Calculated) area of the wizard.

A 10 second countdown begins to allow the projector white point and brightness to stabilize and no changes can be made. At the end of the countdown period, the Color Sensor values fields are automatically populated by the projector for the currently selected drive percentage value.

- b) When the countdown ends, take x, y, and fL measurements using the spectroradiometer. Christie recommends taking meter readings from the center of the screen to obtain accurate screen measurements.

- c) Under Measured Values, using the numeric keypad record the associated spectroradiometer values for x, y, and fL.

The projector holds the on-screen color and brightness level until the same or another Capture button is selected.

- d) Repeat steps a to c for the remaining drive percentage set points until all x, y, and fL values are entered.

Spectroradiometer measurements can be captured in any order but all three x, y, and fL measurements must be entered before moving onto the next capture. You can recapture a specific measurement at any time during the process by selecting the Capture button. In this case, the measured spectroradiometer and color sensor values are reset.

- e) Once all the color sensor and measured values are entered for all nine rows, select **Apply and Save**.

8. Verify and complete the calibration.

- a) Select a white point to measure by selecting either the **DCI**, **D65**, or **Custom** white point buttons.

Once selected, the projector automatically enables LiteLOC™, selects a White test pattern with uncorrected colors at the white point specified, and sets the brightness to 80%.

- b) Using a spectroradiometer, measure screen x and y values at the center of the screen.
To verify the calibration has been successfully applied, the measured white point must be within the expected tolerance.
- c) When complete, select **Finish**.
The projector output is configured according to the currently selected calibration file and you are returned to the Sensor-to-screen Calibration menu.

Recalibrating an existing calibration file

The Sensor-to-screen Calibration wizard guides you through the steps required to re-calibrate an existing calibration file, if required.

1. Select **Menu > Color Settings > Sensor-to-screen Calibration**.

2. Select a user-defined calibration file to recalibrate.

3. Select **Recalibrate**.

The projector checks if the light source is on and the douser is open. If either condition is not met, a warning dialog is displayed prompting you to make sure these conditions are met before starting the wizard.

4. In step 1 of the Sensor-to-screen Calibration wizard, set the maximum brightness and color point.

- a) Enable the **Display White Test Pattern** option.
- b) To set the maximum expected room and chiller (for chiller-based products) temperatures, use the plus (+) or minus (-) signs.
- c) Adjust the RGB sliders to set the brightness and color point.
- d) Select **Next**.

5. Wait 20 minutes for the projector to stabilize or select **Skip** during the stabilization time period.

6. In step 2 of the Sensor-to-screen Calibration wizard, measure and enter the screen values.

- a) To trigger the measurement at a specific operating point, under Sensor to screen, select **Capture**.

The Capture button changes color to indicate the capture process is activated. Only one Capture button is active at a time but the buttons can be selected in any order.

The projector automatically sets the red, green, and blue output laser powers to the pre-determined settings calculated and displayed in the Drive Percentage (Calculated) area of the wizard.

A 10 second countdown begins to allow the projector white point and brightness to stabilize and no changes can be made. At the end of the count down period, the Color Sensor values fields are automatically populated by the projector for the currently selected drive percentage value.

- b) When the countdown ends, under Measured Values, using the numeric keypad capture and record the associated spectroradiometer values for x, y, and fL.

The projector holds the on-screen color and brightness level until the same or another Capture button is selected.

- c) Repeat steps a and b for the remaining drive percentage set points until all x, y, and fL values are entered.

Spectroradiometer measurements can be captured in any order but all three x, y, and fL measurements must be entered before moving onto the next capture. You can recapture a

- specific measurement at any time during the process by selecting the Capture button. In this case, the measured spectroradiometer and color sensor values are reset.
- d) Once all the color sensor and measured values are entered for all nine rows, select **Apply and Save**.
7. Verify and complete the calibration.
- a) Select a white point to measure by selecting either the **DCI, D65**, or **Custom** white point buttons.
Once selected, the projector automatically enables LiteLOC™, selects a White test pattern with uncorrected colors at the white point specified, and sets the brightness to 80%.
 - b) Using a spectroradiometer, measure screen x and y values at the center of the screen.
To verify the calibration has been successfully applied, the measured white point must be within the expected tolerance.
 - c) When complete, select **Finish**.
The projector output is configured according to the currently selected calibration file and you are returned to the Sensor-to-screen Calibration menu.

Editing the existing calibration file parameters

Make corrections to the existing calibration file parameters, when the values from the spectroradiometer were entered in error.

1. Select **Menu > Color Settings > Sensor-to-screen Calibration**.
2. Select a user-defined calibration file.
3. Edit any of the x, y, or fL values by selecting the field under Measured Values and using the numeric keypad to enter the updated value.
 - x and y value range: 0.0001 to 0.9999
 - fL value range: 0.01 to 9999.99.
4. To save the updated file to the projector, select **Save**.

Verifying the sensor-to-screen calibration

Check the integrity of the calibration, if required.

1. Navigate to **Menu > Color Settings > Sensor-to-screen Calibration**.
2. In the right toolbar, select **Test Patterns**. 
3. Select the **White** test pattern.
4. Close the Test Patterns window.
5. Select **Verify Calibration**.

If the douser is closed and/or the light source is off, a dialog is displayed informing the user that the douser must be open and the light source turned on before verification can occur.

Step 3 of the Calibration wizard opens.

6. Verify and complete the calibration.
 - a) Select a white point to measure by selecting either the **DCI, D65**, or **Custom** white point buttons.

- Once selected, the projector automatically enables LiteLOC™, selects a White test pattern with uncorrected colors at the white point specified, and sets the brightness to 80%.
- b) Using a spectroradiometer, measure screen x and y values at the center of the screen. To verify the calibration has been successfully applied, the measured white point must be within the expected tolerance.
 - c) When complete, select **Finish**.
The projector output is configured according to the currently selected calibration file and you are returned to the Sensor-to-screen Calibration menu.

Adding a calibration file to the Channel Setup

Select any of the available calibration files stored on the projector system by accessing the 2D Sensor-to-Screen Calibration File or 3D Sensor-to-Screen Calibration File list in the Channel Setup menu.

By default, the 2D and 3D sensor-to-screen calibration files are set to the factory or field calibration data identified as Default in the list. The Default selection references the factory calibration data as long as no field calibration data is available. If field calibration data is available, it is selected as the Default. When a 2D and 3D Sensor-to-screen Calibration file is selected in the Channel Setup, the active channel automatically applies the calibration data according to the 2D or 3D operation of the projector.

1. In the left navigation menu, select **Channel Setup**.
2. Select the channel you want to add the calibration file to.
3. From either the **2D Sensor-to-Screen Calibration File** or **3D Sensor-to-Screen Calibration File** list, select the calibration file.
4. Select **Save**.

Adjusting the image

Learn how to adjust image geometry so it displays correctly.

Calibrating the Intelligent Lens System

On Cinema 2K-RBe projectors, the Intelligent Lens System (ILS) is activated by default.

Use the Auto Calibrate feature of the ILS to find and compensate for motor backlash, and to determine the movement range for the currently installed lens.

1. In the left navigation menu, select **Image Settings > ILS File Setup**.
2. From the ILS File list, select an available ILS file.
3. Select **Auto Calibrate**.
4. Select **Continue**.
The system performs the lens calibration.

Correcting vignetting

An image that is brighter at the center than it is at the sides needs vignetting correction.

If your image suffers from vignetting, the lens has reached the end of its offset travel range.

If your installation does not allow the image to be centered with the center of the screen, move the entire projector in the direction of lens travel.

Adjusting tilt and leveling the projector

To ensure optimum performance, install the projector so it is centered and parallel with the screen.

To compensate for tilt or offset, you can adjust the projector feet and the lens mount position.

This product must be installed in a landscape orientation, with all four feet supported on a level surface. Do not install or operate the projector in an inverted position. If your site has any installation requirements other than a typical theater projection booth, contact Christie for assistance.



The front-to-back tilt of the projector must not exceed 15° in a downward direction or 5° in an upward direction. The side-to-side tilt must be within +3° to -3° of level.

1. To adjust the height of the projector, loosen the lock nut on the adjustable feet on the bottom of the projector.

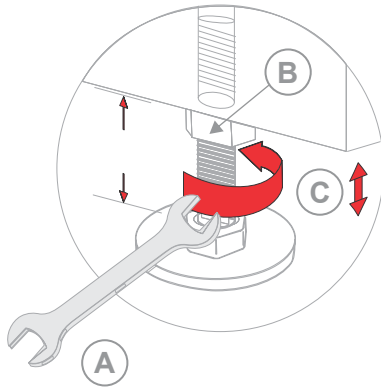

A	Wrench
B	Lock
C	Turn to adjust height

2. Extend or retract the feet.



Feet cannot be extended more than 228.6 mm (9 inches) from the projector bottom to the bottom of feet. A safety hazard exists if loosening more than this amount. If more than 228.6 mm (9 inches) is needed to achieve the ~15° downward tilt, follow the steps in *Installing the extension feet* (on page 48)

3. When the adjustment is correct, tighten the lock nut.

Installing the extension feet

Follow these steps to install the extension feet.

1. Loosen the six screws to remove the side-intake (right-side) cover.
2. Loosen the bottom nut from the baseplate.
3. Un-thread the entire 2x extensions from the baseplate and set aside.
4. Safely hold projector at least 304.8 mm (12 inches) off the surface, based on how high you want to raise up the rear of projector to the maximum downward tilt of 15°.
5. Remove the 2x rear feet.
Unlock the lock nut with a wrench and thread both feet out of the foot holes.
6. Thread in both extensions into the rear threaded foot holes.
Make sure the small nut is threaded up to the big nut on the extensions.
7. Thread the 2x rear feet to bottom out into the lower nuts on the extension feet.
8. Adjust the heights of both extension feet to the required approximate length.
9. Prior to putting weight on projector, lock the foot nut up against the extension big nut.
Torque to 30in-lbs.
10. Lock the small extension nut up against the bottom of the projector.
Torque to 30in-lbs.

Correcting keystone effect

Keystone effect occurs when you project an image onto the screen at an angle. As a result, the image appears distorted and resembles a trapezoid.

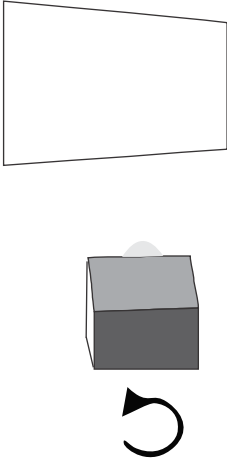
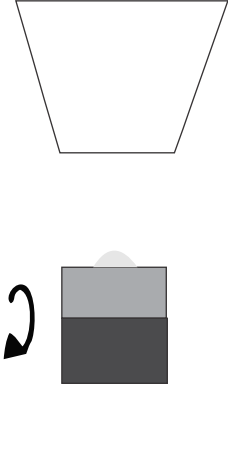

When making the adjustments, set the light source to minimum power.

Horizontal keystone	Vertical keystone
	
Projector skewed horizontally to the screen	Projector tilted vertically to the screen

1. If the image suffers from slight keystone effect, it can be corrected with electronic cropping.
2. If the keystone effect is severe, unevenly adjust the feet to compensate for projector tilt. Christie recommends using the lens offset to align the center of the image to the center of the screen before correcting the keystone effect.
3. If one side of the image is longer than another, adjust the tilt and level of the projector.

Adjusting the fold mirror

Learn how to align the fold mirror with the optical system to correct an image with missing or shadowy corners or edges.

1. Remove the top cover.
2. Display the **RGB-12bit-Full Screen White** test pattern.
3. Insert a hex driver in the first set screw (A) and a hex driver in the first cap screw (B).

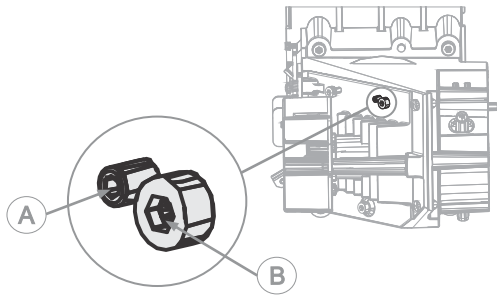

4. Equally turn the set screw (A) and cap screw (B) in opposite directions until the black corner is removed.
5. If the black corner remains, insert a hex driver in the second set screw (C) and a hex driver in the second cap screw (D).

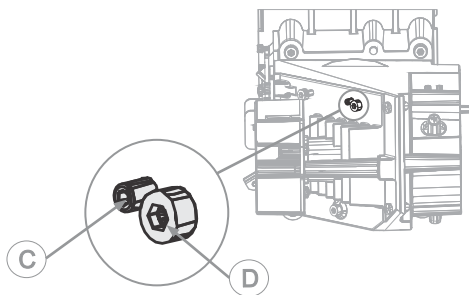

6. Equally turn the set screw (C) and cap screw (D) in opposite directions until the black corner is removed.
7. Replace the top cover.

Displaying a test pattern

Display a test pattern to refine and adjust the projected image or to diagnose and correct image issues.

1. In the right toolbar, select **Test Patterns**. 
2. Select **Full Screen**.
3. Select a test pattern.
When a test pattern is active, a blue bar appears below the test pattern icon in the right pane.
4. To display a 2D test pattern in 3D mode, select the **3D Sync** option.
The **3D Sync** option is selected automatically for 3D test patterns. 3D test patterns cannot be displayed in 2D mode.
5. To change the frame rate of the test pattern display, select from the available Frame Rate options:
 - For 2D test patterns, the available frame rates are 24, 30, 48, and 60 Frames Per Second (FPS). The default value is 24 FPS.
 - For 3D test patterns, the available frame rates are 48 and 60 FPS. The default value is 48 FPS.

Changing the frame rate of the display can assist with color measurement when working with corrected colors.

When changing the frame rate option, the option is applied to the next test pattern you select unless it is not available for that pattern. If a selected frame rate is not available, the default frame rate is applied for the test pattern display.

Aligning the boresight

The boresight adjustment balances the tilt of the lens mount to compensate for screen-to-projector tilt.



Caution! If not avoided, the following could result in minor or moderate injury.

- Do not look directly into the lens when the light source is on. The extremely high brightness can cause permanent eye damage.

- Display the boresight test pattern.
 - In the right toolbar, select **Test Patterns**. 
 - Select the **RGB-2K-Boresight** pattern and display it full screen.

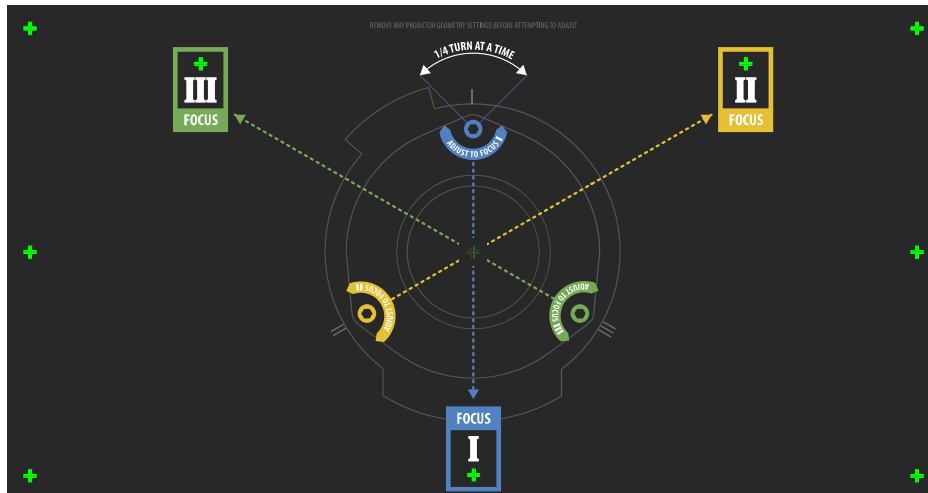

- Focus the image on cross-hair image **I**.
- Evaluate the focus on cross-hair image **II** and **III**.
 - If all three images are in focus, no further action is required.
 - If boresight is required, continue to step 4.

The adjustment screws (A) on the lens mount affects the corresponding cross-hairs on the test pattern.

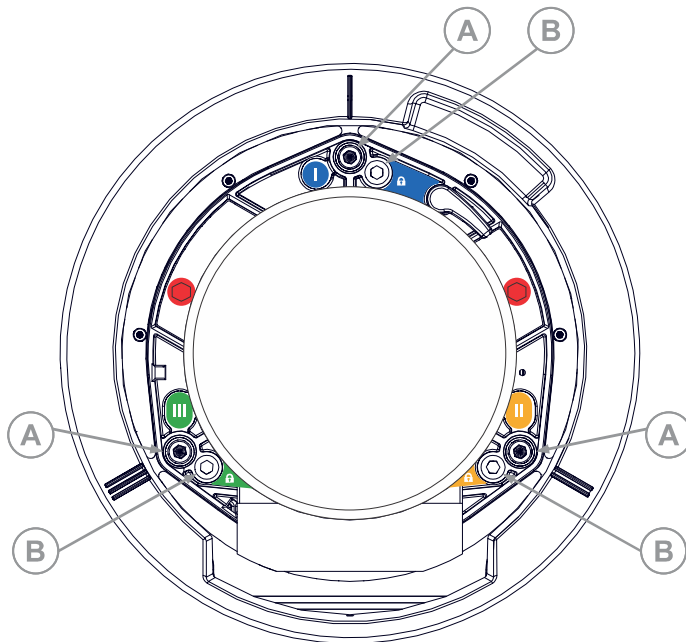

4. To loosen the three setscrews (B) on the lens mount, use a 5 mm hex driver. The setscrews must be backed out several turns to avoid contact with the inner lens mount plate.
5. To fine tune the focus of cross-hair pattern **I**, adjust the appropriate adjustment screw (A) until the cross-hair image is in focus with minimal flare.

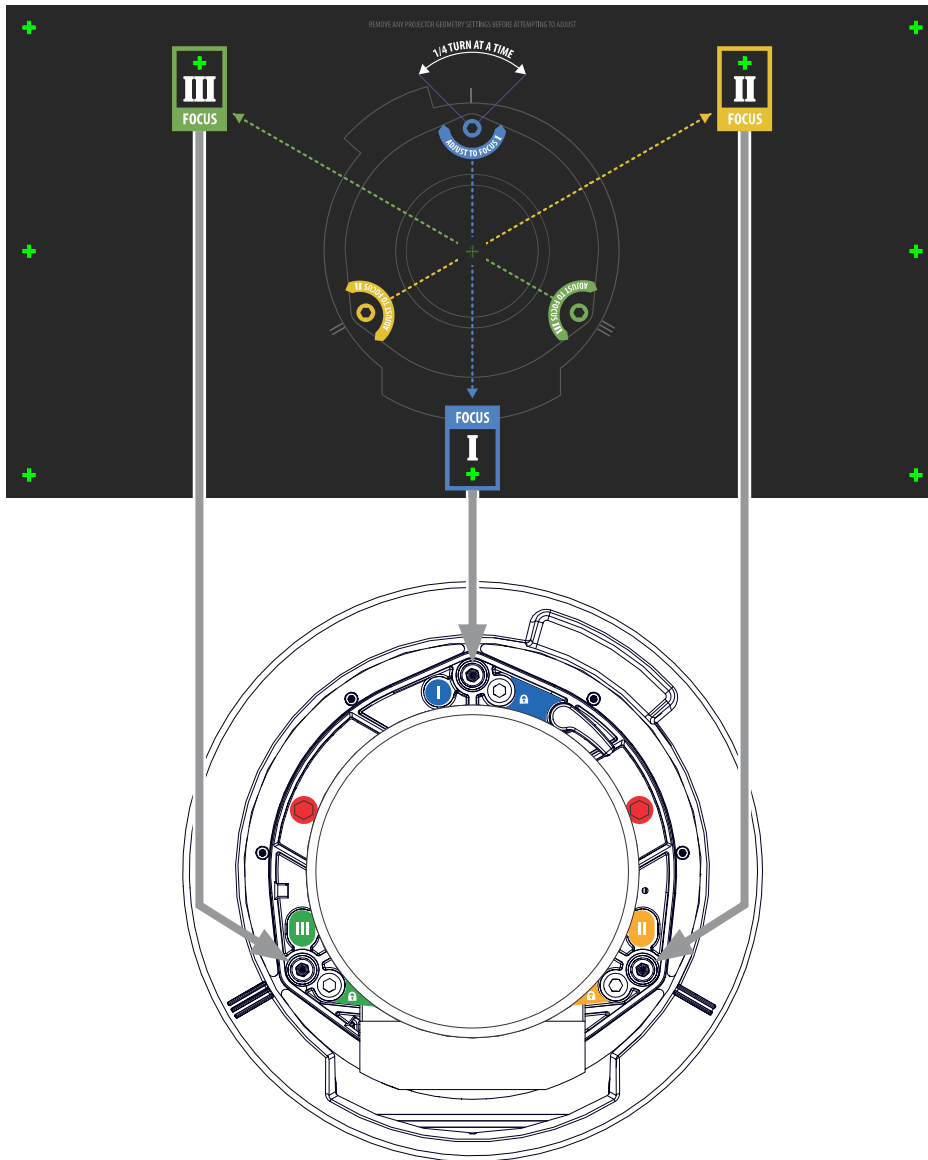

6. To fine tune cross-hair pattern **II**, adjust the appropriate adjustment screw until the cross-hair image is in focus with minimal flare.
7. To fine tune cross-hair pattern **III**, adjust the appropriate adjustment screw until the cross-hair image is in focus with minimal flare.
8. Repeat step 5 to 7 as required until all three cross-hair patterns are in equal sharp focus.
 - If the boresight is acceptable, proceed with step 11.
 - If the boresight does not appear to be converging to an acceptable level of image quality, or if the lens does not focus over the correct range of throw distances, proceed with step 9.
9. To approximately recover the original factory boresight, position the three setscrews flush with the front face of the lens mount plate and in contact with the inner lens mount plate. This may require adjusting both setscrews and adjustment screws.

10. If further action is required, repeat steps 2 to 9.
11. Lock the setscrews, and re-check the boresight quality.
Tighten the setscrews to 2.1 Nm (18 in-lb) to make sure they do not shift.

Mechanically adjusting digital micromirror device (DMD) convergence

A convergence problem can be identified when one or more projected colors (red, green, and blue) appears misaligned when examined with a convergence test pattern.

The physical layout of the green and blue formatter boards dictates the behavior of the twist and vertical adjustments:

- The adjustment of the two is more like a twist with the left-side of the screen as a sliding hinge point to allow vertical travel.
- The vertical adjustment screw and twist adjustment screw interact with each other so if one is turned in the opposite direction of the other, the twist is affected.
- If both screws are turned equal amounts in the same direction, the image moves vertically.

1. Before adjusting digital micromirror device (DMD) convergence, make sure the projector has reached a steady operational state.

If switching from a white or bright test pattern to a dark convergence test pattern or if warming up the projector after a shutdown, allow 15 minutes for stabilization so the optics can reach a steady state.

2. In the right toolbar, select **Test Patterns**. 
3. Select the **RGB-2K-Convergence** test pattern and display it full screen.

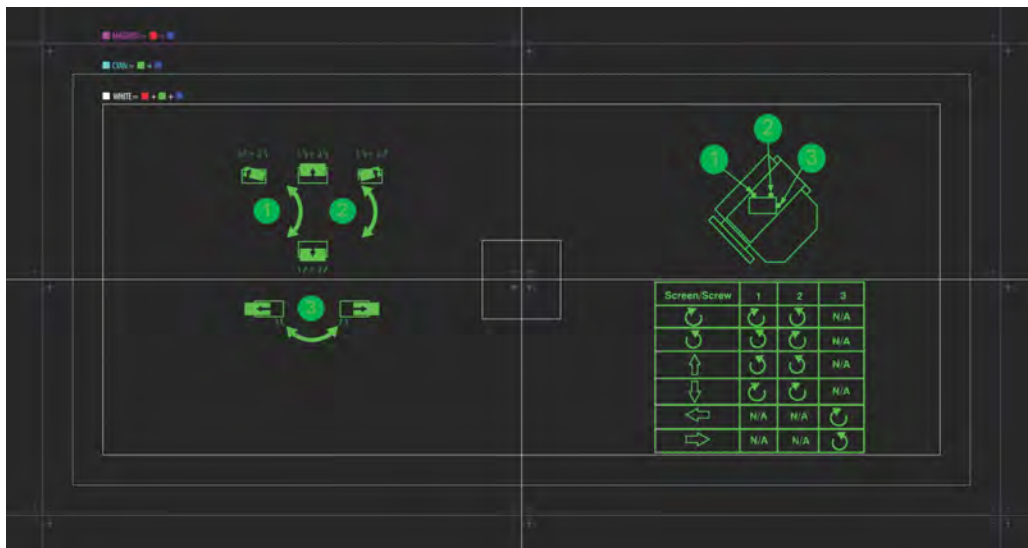

4. Access the screws on the light engine.

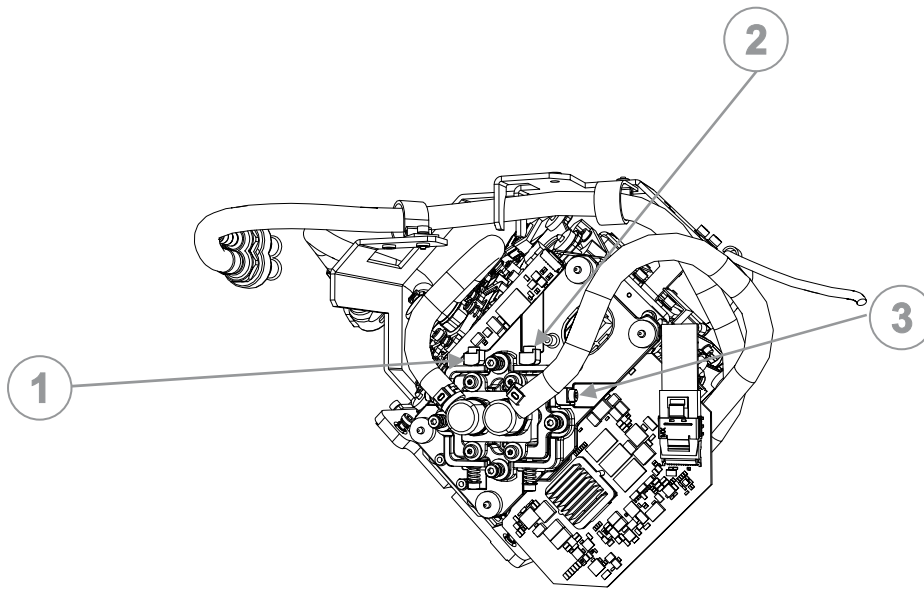

5. Use the Convergence test pattern to assist with adjusting the horizontal and vertical lines.
6. Locate the shorter blade 2.5 mm driver on adjusting screw #2 and use the longer blade 2.5 mm driver for screw #1 and horizontal (screw #3).
Do not apply excessive force on the adjustment screws. This can cause the convergence adjustment to become misaligned once you remove the adjustment tool.
7. Locate the twist adjustment screw with the 2.5 mm Allen driver and leave it in place, resting against the lens mount/formatter board.
You do not always have to turn the screws simultaneously; however, adjusting one at a time causes the need for an equal or equal and opposite turn on the other to prevent binding to achieve the required adjustment. If attempting to adjust the twist and increased resistance is encountered on the twist adjustment screw, do the following:

Screen/screw	1	2	3
↻	↻	↻	—
↻	↻	↻	—
↑	↻	↻	—
↓	↻	↻	—
←	—	—	↻
→	—	—	↻

8. Insert and remove a second driver to adjust the horizontal/twist adjustment screw or the vertical adjustment screw.

Electronic Color Correction (ECC)

A lateral convergence error occurs when the red, green, and blue (RGB) primary colors are not converged through projected lenses and is most noticeable at the edges of the screen. To address this, use ECC.

Electronic Color Correction (ECC) is accomplished by aligning a red, green, and blue sprite, which is displayed at the four corners of the displayed image. For electronic convergence all three colors can be adjusted.

Always align the color components of the sprite to the inner most line color (for each axis). When converged, the three colors should overlap to form white lines. Applying the sprite alignment settings to the screen results in the three colors overlapping to form white lines throughout the image.

One or more poorly converged individual colors may appear adjacent to some or all of the lines.

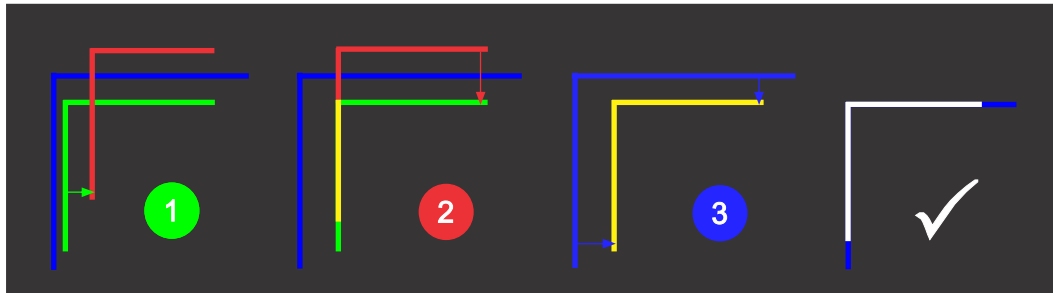

If you wear glasses with corrective lenses when performing this adjustment, make sure you are viewing the test pattern on a straight angle through the optical axis of your glasses and not from a tilted or angled perspective. This avoids a prismatic effect that can appear to shift convergence when viewing at an angle.

Electronically adjusting convergence

Use the electronic convergence feature in the menu to adjust convergence. Only perform electronic convergence when satisfied with the position of the image on the screen.

1. Let the projector warm up for 20 minutes before proceeding with the following steps.
2. In the left navigation menu, select **Image Settings > ILS File Setup**.
3. Use the arrow to select an ILS file to store the ECC settings.
4. On the ILS File Setup page, select **ECC**. 

Each corner of the screen displays three separate sprites, one for each primary color. The user interface displays the Test Pattern controls.

5. Set the Screen Type to **Flat** or **Scope**.
This sets the test pattern and the location of the sprites on the screen. Each sprite appears as the letter L.
6. Set the Sprite Color to **Move** and **Show**.
When first opening the ECC, all Show and all Move colors are selected, so all three sprites are displayed and all three sprites are moved by the directional pad.
7. Select a **Step Size** to control the granularity of the steps from coarse (1/8 pixel per step) to fine (1/64 pixel per step) when using the directional pad.
Sprites can be moved a maximum of 20 pixels.
8. Choose a corner by selecting the circle at a corner of the dashed rectangle.

The selected corner is indicated by a green circle. The X/Y pixel offset (from no correction) displays in red, green, and blue text corresponding to each sprite.

9. Use the directional pad to move the sprites towards the center of the screen.
10. Adjust each sprite so they overlap to create a single white sprite.

In the example below, the red sprite (in image 1 below) was moved down and the blue sprite (in image 1 below) was moved to the right so they overlap to create the single white sprite (image 2 below).

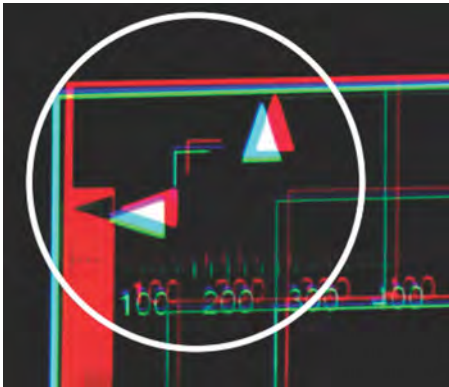

1

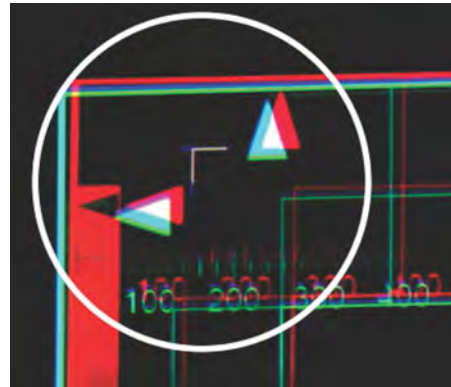

2

11. To set the convergence for that corner of the screen, select **Apply**.



12. Repeat steps 7 to 10 for the remaining corners.
13. If necessary, reset the correction back to zero (no correction) or the previously saved correction by selecting **Reset**.
In the Reset dialog, reset the current corner or all four corners. When the locations and value are set, select **Reset**.
14. To save the current ECC settings, when the convergence is complete, select **Save** beside the ILS file named at the top of the panel.

Correcting on-screen color

After installation, further image adjustments may be required to correct color on the screen.

The next steps may include creating a Measured Color Gamut Data (MCDG) file and configuring a Pureformity Color™ Technology (PCT) file to achieve optimal color and brightness uniformity.

For more information on managing color settings, see the *CineLife+ 2.0 User Guide (P/N: 020-103845-XX)*.

Regulatory

This product conforms to the latest regulations and standards related to product safety, environmental, and electromagnetic compatibility (EMC) requirements.

Safety

- IEC 62368-1:2018 - Audio/Video, Information And Communication Technology Equipment - Part 1: Safety Requirements
- BS EN 62368-1:2014 - Audio/Video, Information And Communication Technology Equipment - Part 1: Safety Requirements
- UL 62368-1:2018 - Audio/Video, Information And Communication Technology Equipment - Part 1: Safety Requirements
- CSA CAN/CSA-22.2 No. 62368-1:2018 - Audio/Video, Information And Communication Technology Equipment - Part 1: Safety Requirements
- IEC/EN 62471-5 – Photobiological Safety of Lamps and Lamp Systems – Part 5: Image projectors
- IEC 60825-1:2014 - Safety of Laser Products - Part 1: Equipment Classification and Requirements
- ANSI Z136.1 (2014) – Safety of Lasers

Electro-magnetic compatibility

Emissions

- CAN ICES-003 (A)/NMB-003 (A) – Information Technology Equipment (Including Digital Apparatus) – Limits and Methods of Measurement
- CISPR 32/EN 55032, Class A – Electromagnetic Compatibility of Multimedia Equipment – Emission Requirements
- FCC CFR47, Part 15, Subpart B, Class A – Unintentional Radiators
- IEC 61000-3-2/EN61000-3-2: Limits for harmonic current emissions for equipment with input current ≤ 16 A
- IEC 61000-3-3/EN 61000-3-3: Limitations of Voltage Changes, Voltage Fluctuations, and Flicker input current ≤ 16 A per phase and not subject to conditional connection

Immunity

- CISPR 35/EN 55035 Electromagnetic compatibility of multimedia equipment - Immunity requirements

California law on security

- California Law Requiring Internet Connected Devices To Include Reasonable Security Features (California Civil Code Section 1798.91.04)

Environmental

- China Ministry of Information Industry (along with 7 other Government Agencies) Order No.32 (01/2016) on the control of pollution caused by electronic information products, hazardous substances concentration limits (GB/T 26572 - 2011), and the applicable product marking requirement (SJ/T 11364 - 2014).
- EU Directive (2011/65/EU) on the restriction of the uses of certain hazardous substances (RoHS) in electrical and electronic equipment and the applicable official amendment(s).
- EU Directive (2012/19/EU) on waste and electrical and electronic equipment (WEEE) and the applicable official amendment(s).
- Regulation (EC) No. 1907/2006 on the registration, evaluation, authorization and restriction of chemicals (REACH) and the applicable official amendment(s).

International packaging recycling mark requirements.

- EU Directive (2012/19/EU) on waste and electrical and electronic equipment (WEEE) and the applicable official amendment(s).
- EU Directive (94/62/EC) on packaging and packaging waste
- China packaging recycling mark standard (GB18455-2010)