

The top half of the page features a complex, abstract background of overlapping, semi-transparent blue triangles and polygons in various shades of blue, ranging from light sky blue to deep navy blue. This pattern transitions into a clean white background at the bottom.

User Manual

020-002053-02

Christie HS Series 4K

CHRISTIE®

NOTICES

COPYRIGHT AND TRADEMARKS

Copyright © 2024 Christie Digital Systems USA, Inc. All rights reserved.

All brand names and product names are trademarks, registered trademarks or trade names of their respective holders.

GENERAL

Every effort has been made to ensure accuracy, however in some cases changes in the products or availability could occur which may not be reflected in this document. Christie reserves the right to make changes to specifications at any time without notice. Performance specifications are typical, but may vary depending on conditions beyond Christie's control such as maintenance of the product in proper working conditions. Performance specifications are based on information available at the time of printing. Christie makes no warranty of any kind with regard to this material, including, but not limited to, implied warranties of fitness for a particular purpose. Christie will not be liable for errors contained herein or for incidental or consequential damages in connection with the performance or use of this material. Our centers of excellence for manufacturing in Kitchener, Ontario, Canada and in Shenzhen, China are ISO 9001:2015 Quality Management System-certified.

Christie is committed to making our documents free from language bias; however, we are not responsible for the language used on any linked or third-party documentation.

For the most current technical documentation and office contact information, visit www.christiedigital.com.

WARRANTY

Products are warranted under Christie's standard limited warranty, the details of which are available at <https://www.christiedigital.com/help-center/warranties/> or by contacting your Christie dealer or Christie.

PREVENTATIVE MAINTENANCE

Preventative maintenance is an important part of the continued and proper operation of your product. Failure to perform maintenance as required, and in accordance with the maintenance schedule specified by Christie, will void the warranty.

REGULATORY (if applicable)

The product has been tested and found to comply with the limits for a Class A digital device, pursuant to Part 15 of the FCC Rules. These limits are designed to provide reasonable protection against harmful interference when the product is operated in a commercial environment. The product generates, uses, and can radiate radio frequency energy and, if not installed and used in accordance with the instruction manual, may cause harmful interference to radio communications. Operation of the product in a residential area is likely to cause harmful interference in which case the user will be required to correct the interference at the user's own expense. Changes or modifications not expressly approved by the party responsible for compliance could void the user's authority to operate the equipment.

CAN ICES-003 (A) / NMB-003 (A)

이 기기는 업무용 (A 급) 으로 전자파적합등록을 한 기기이오니 판매자 또는 사용자는 이점을 주의하시기 바라며, 가정 외의 지역에서 사용하는 것을 목적으로 합니다.

ENVIRONMENTAL



The product is designed and manufactured with high-quality materials and components that can be recycled and reused. This symbol  means that electrical and electronic equipment, at their end-of-life, should be disposed of separately from regular waste. Please dispose of the product appropriately and according to local regulations. In the European Union, there are separate collection systems for used electrical and electronic products.

If printing this document, consider printing only the pages you need and select the double-sided option.

Please help us to conserve the environment we live in!

NOTATION

Learn the hazard and information symbols used in the product documentation.



Danger! If not avoided, the following could result in death or serious injury.



Warning! If not avoided, the following could result in death or serious injury.



Caution! If not avoided, the following could result in minor or moderate injury.



Notice. If not avoided, the following may result in equipment or property damage.

Content

- Introduction 8**
 - Models 8
 - Safety and warning guidelines 8
 - AC/power precautions 9
 - Installation safety and warning guidelines 9
 - Laser safety precautions 9
 - Light intensity hazard distance 10
 - Product labels 12
 - Projector overview 14
 - Contact your dealer 14
 - Key features 14
 - How the projector works 15
 - List of components 15
 - Product documentation 16
 - Related documentation 16
 - Technical support 16
 - Additional information 17

- Installation and setup 18**
 - Site requirements 18
 - Physical operating environment 18
 - Power connection 18
 - Projector components 19
 - Front view 19
 - Rear view 19
 - Left view 20
 - Right view 20
 - Built-in keypad 21
 - Input/output (I/O) panel 22
 - IR remote keypad 23
 - Positioning the display 25
 - Turning on the projector 26
 - Turning off the projector 26
 - LED status indicator 27

Status LED	27
Shutter LED	27
Adjusting the size and position	28
Setting the image size preset	28
Setting the digital size of display image	29
Setting the digital position of display image	29
Geometry correction	29
Enabling geometry correction	29
Saving geometry correction	29
Applying geometry correction	30
Enabling basic image blending	30
Blending multiple images	31
Downloading a blend from the projector memory	31
Adjusting horizontal keystone	32
Adjusting the vertical keystone	32
Adjusting horizontal pincushion	32
Adjusting vertical pincushion	33
Adjusting 4-corner	33
Enabling auto warp filter	33
Adjusting warp filter	34
Resetting geometry correction setting	34
Configuring warp and blend	34
Warping an image	34
Downloading a warp from the projector memory	35
Performing auto warp and blend	35
Adjusting the image settings	36
Adjusting the brightness	36
Adjusting the contrast	36
Adjusting the color space	36
Adjusting the image sharpness	37
Setting up 3D display	37
Setting 3D mode	37
Setting 3D format	37
Inverting 3D signal	38
Selecting the 3D sync input signal	38
Setting the 3D sync output signal	39
Setting the frame delay	39

- Setting the sync delay 39
- Configuring the video settings 39
 - Adjusting black and white video 39
 - Adjusting the color balance 40
- Configuring picture settings 40
- Applying customized user configuration setting 41
- Editing customized picture setting 41
- Setting the contrast ratio 42
- Enabling the image freeze 42
- Setting the high dynamic range 43
- Adjust the color of the image 43
 - Adjusting primary colors 44
 - Setting the wall color 45
 - Setting the wall color automatically 45
- Adjusting the image settings automatically 45
 - Adjusting the image with automatic focus 45
 - Setting the wall color automatically 46
 - Balancing the image color automatically 46
- Adjusting advanced image settings 47
 - Adjusting the color value based on gamma setting 47
 - Adjusting the white peaking 47
 - Adjusting the color temperature 47
 - Saving user settings for data recovery 48
- Configuring system settings 49**
 - Changing the language 49
 - Adjusting lens settings 49
 - Viewing the lens type 49
 - Aligning the image with focus, zoom, and auto focus 50
 - Adjusting the image with automatic focus 50
 - Adjusting lens position 50
 - Saving lens setting 51
 - Applying the previous lens setting 51
 - Locking the lens motor 51
 - Resetting the lens to home position 51
 - Selecting screen image orientation 52
 - Adjusting on-screen display menus 52
 - Determining the on-screen display position 52
 - Showing messages 52

- Setting the transparency of the on-screen display position 53
- Changing the splash screen 53
- Setting time out for on-screen display 53
- Setting up password protection 54
- Changing password 54
- Setting up power mode 54
 - Setting the standby mode 54
 - Setting the AC power 55
 - Setting the time for auto shutdown 55
 - Setting the sleep timer 55
- Enabling high altitude setting 55
- Setting the projector communication 56
- Enabling the 12V Trigger 56
- Configuring communications 57**
 - Setting network environment 57
 - Adjusting LAN setting 57
 - Using the web interface 58
 - Logging on to the web user interface 58
 - Setting the system notification 58
 - Using the RS-232C interface 59
 - Re-connecting the network 59
 - Adjusting WLAN setting 60
 - Adjusting network setting 60
 - Setting serial port baud rate 60
 - Enabling serial port echo 60
 - Setting the projector address 61
 - Adjusting the back light settings 61
 - Setting the hot key 61
 - Configuring date and time settings 62
 - Scheduling events 62
 - Setting up a schedule 63
- Configuring light settings 65**
 - Setting light source mode 65
 - Adjusting the light power 66
- Diagnostic tools 67**
 - Viewing projector information 67

Selecting a test pattern 67

Restoring factory default settings 68

Configuring input settings 69

 Setting main input source 69

 Setting second input source 69

 Enabling second input source 69

 Swapping main input and second input source 70

 Setting the size of second input source 70

 Setting up the display layout with two input sources 70

 Input sources layout and size 70

 Setting the timing detection mode 71

 Setting the input searching method 71

 Setting up the backup input 72

 Adjusting the sub image 72

 Enabling low latency mode 72

 Configuring the EDID setting 73

 Configuring the HDMI output 73

Signal connectivity specifications 74

 HDMI1/HDMI2 video formats 75

 Display Port video formats 78

 12G-SDI video formats 81

 HDBaseT video formats 82

 Picture-in-picture/picture-by-picture (PIP/PBP) compatibility 85

Regulatory 86

 Safety 86

 Laser safety 86

 Electro-magnetic compatibility 86

 Emissions 86

 Immunity 87

 California law on security 87

 Environmental 87

Introduction

This manual is intended for Christie-qualified installers and trained operators of the projector. For complete HS Series 4K product documentation and technical support, go to www.christiedigital.com.

This projector is intended for use in a non-cinema environment.

Models

The following models are supported for the HS Series 4K.

- 4K13-HS
- 4K13A-HS
- 4K22-HS
- 4K22A-HS

Safety and warning guidelines

This projector must be operated in an environment that meets the operating range specification. Use only the attachments and/or accessories recommended by Christie. Use of others may result in the risk of fire, shock, or personal injury.



Warning! If not avoided, the following could result in death or serious injury.

- Do not expose the product to moisture.
- Do not operate the product without all of its covers in place.
- This product must be installed within a restricted access location not accessible by the general public.
- Only personnel who are trained on the precautions for the restricted access location can be granted entry to the area.
- FIRE HAZARD! Keep hands, clothes, and all combustible material away from the concentrated light beam of the projector.
- TRIP OR FIRE HAZARD! Position all cables where they cannot contact hot surfaces, be pulled, be tripped over, or damaged by persons walking on or objects rolling over the cables.
- SHOCK HAZARD! Disconnect the product from AC before installing, moving, servicing, cleaning, removing components, or opening any enclosure.
- A minimum of two people or appropriately rated lift equipment is required to safely lift, install, or move the product.
- OPTICAL RADIATION HAZARD! Disconnect the power plug from the AC outlet if the product is not being used for an extended period of time.
- Do not allow anything to rest on the power cord.
- Always provide proper ventilation for the product to prevent overheating.



Caution! If not avoided, the following could result in minor or moderate injury.

- Only Christie-qualified technicians are permitted to open product enclosures.
- All procedures must be performed by Christie-qualified technicians.



Notice. If not avoided, the following may result in equipment or property damage.

- Always use a lens plug when installing or moving the product. This prevents contaminants from entering the product.
- Only use cleaning solutions recommended by Christie. All other cleaning solutions may cause product damage and void the warranty.

AC/power precautions

Read all safety and warning guidelines before powering on the projector.



Warning! If not avoided, the following could result in death or serious injury.

- FIRE HAZARD! Do not use a power cord, harness, or cable that appears damaged.
- FIRE OR SHOCK HAZARD! Do not overload power outlets and extension cords.
- SHOCK HAZARD! Only use the AC power cord provided with the product or recommended by Christie.
- FIRE AND SHOCK HAZARD! Do not attempt operation unless the power cord, power socket, and power plug meet the appropriate local rating standards.
- SHOCK HAZARD! Do not attempt operation if the AC supply is not within the specified voltage and current, as specified on the license label.
- SHOCK HAZARD! The AC power cord must be inserted into an outlet with grounding.
- SHOCK HAZARD! Disconnect the product from AC before installing, moving, servicing, cleaning, removing components, or opening any enclosure.
- Install the product near an easily accessible AC receptacle.

Installation safety and warning guidelines

Read all safety and warning guidelines before installing the projector.

Laser safety precautions

Read all safety and warning guidelines before installing or operating the projector.



Warning! If not avoided, the following could result in death or serious injury.

- LASER RADIATION HAZARD! This projector has a built-in Class 4 Laser module. Never attempt to disassemble or modify the laser module.
- Any operation or adjustment not specifically instructed in the User manual creates the risk of hazardous laser radiation exposure.
- Do not operate the product without all of its covers in place.
- Do not look directly into the lens when the light source is on. The extremely high brightness can cause permanent eye damage.
- Only Christie-qualified technicians who are knowledgeable about the hazards associated with laser use, high-voltage, and high temperatures generated by the product are authorized to assemble, install, and service the Christie Laser Projection System.
- Do not look directly into the lens when the light source is on. The extremely high brightness can cause permanent eye damage. Class 1 laser product of IEC/EN 60825-1:2014 and Risk Group 2 according to IEC 62471-5:2015.



Warning! If not avoided, the following could result in death or serious injury.

- Install the product so users and the audience cannot enter the restricted area at eye level.
- Install the product out of reach.
- LASER RADIATION! Do not look directly into the laser beam of the remote.
- Complies with 21 CFR 1040.10 and 1040.11 except for conformance as a Risk Group 2 LIP as defined in IEC 62471-5:Ed. 1.0. For more information see Laser Notice No. 57, dated May 8, 2019. IEC 60825-1:2014: CLASS 1 LASER PRODUCT - RISK GROUP 2.
- For 4K13-HS, 4K13A-HS, 4K22-HS, and 4K22A-HS, no direct exposure to the beam shall be permitted, RG3 IEC 62471-5 when installed with 140- 110103-XX lens (throw ratio 1.5-2.0) or of a higher Throw ratio lens.

Light intensity hazard distance

This projector has been classified as Risk Group 3 according to the IEC 62471-5:2015 standard due to possible hazardous optical and thermal radiation being emitted.



Warning! If not avoided, the following could result in death or serious injury.

- PERMANENT/TEMPORARY BLINDNESS HAZARD! No direct exposure to the beam must be permitted.
- PERMANENT/TEMPORARY BLINDNESS HAZARD! Operators must control access to the beam within the hazard distance or install the product preventing potential exposure of the spectators' eyes from being in the hazard distance. Hazard zone shall be no lower than 3.0 meters (9.8 feet) above the floor. In addition, horizontal clearance to the hazard zone shall be a minimum 2.5 meters (8.2 feet).
- EXTREME BRIGHTNESS! Do not place reflective objects in the product light path.

The following diagram shows the zones for optical and skin hazard distances:

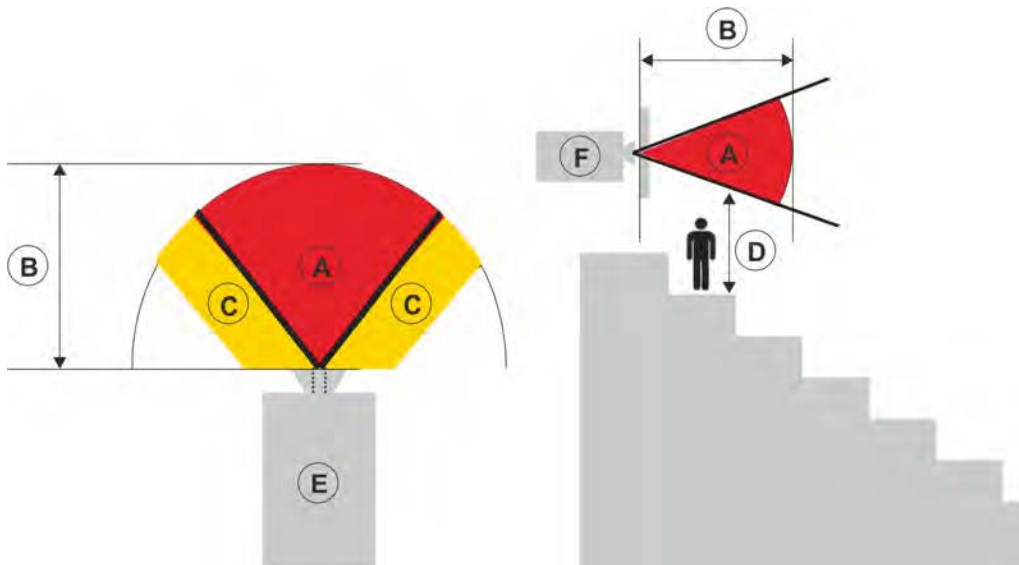

- A—Hazard zone. The region of space where the projection light from the laser illuminated projector is above emission limits for Risk Group 3. The light intensity may cause eye damage after a momentary or brief exposure (before a person can avert his or her eyes away from the light source). The light may cause skin burns to occur.
- B—Hazard distance. Operators must control access to the beam within the hazard distance or install the product preventing potential exposure of the spectators' eyes from being in the hazard distance.
- C—No access zone. Horizontal clearance of the no access zone shall be a minimum of 2.5 meters (8.2 feet).
- D—Vertical distance to hazard zone. The hazard zone shall be no lower than 3.0 meters (9.8 feet) above the floor.
- E—Represents the top view of the projector.
- F—Represents the side view of the projector.

For information detailing the hazard distance for each lens, refer to the *Christie HS Series 4K Installation and Setup Guide (P/N: 020-002055-XX)*.

For installations in the United States

The following must be in place for laser-illuminated projector installations in the United States:













- Any human access to the hazard zone, if applicable, must be restricted by barriers to enforce the no access zone.
- Permanent show installations containing Risk Group 3 laser-illuminated projectors must meet the following conditions:
 - Installed by Christie or by Christie-authorized and trained installers. Refer to the EXTERNAL - Laser safety awareness training (Course code: CS-ELSA-01) on the <http://www.christieuniversity.com> site.
 - Performed according to instructions provided by Christie.
 - Ensure the projection system is securely mounted or immobilized to prevent unintended movement or misalignment of the projections.
- Temporary show installations containing Risk Group 3 laser-illuminated projectors may be installed by Christie or sold or leased only to valid laser light show variance holders (laser light show manufacturers) for image projection applications. Such manufacturers may currently hold a valid variance for production of Class IIIb and IV laser light shows and/or for incorporation of the Risk Group 3 laser-illuminated projectors into their shows. This requirement applies also to dealers and distributors of these laser-illuminated projectors.
- The Christie Laser Projection System Installation Checklist must be fully completed after the installation and sent to lasercompliance@christiedigital.com. A copy can remain on-site. This checklist can be found as a separate document in the accessory box with the manual.
- Certain US states have additional laser regulatory requirements. Go to www.christiedigital.com for further information.

Product labels

Learn about the labels that may be used on the product. Labels on your product may be yellow or black and white.

General hazards

Hazard warnings also apply to accessories once they are installed in a Christie product that is connected to power.

Fire and Shock Hazard	
 	<p>To prevent fire or shock hazards, do not expose this product to rain or moisture.</p> <p>Do not alter the power plug, overload the power outlet, or use it with extension Cords.</p> <p>Do not remove the product enclosure.</p> <p>Only Christie-qualified technicians are authorized to service the product.</p>
Electrical Hazard	
	<p>Risk of electric shock.</p> <p>Do not remove the product enclosure.</p> <p>Only Christie-qualified technicians are authorized to service the product.</p>
	<p>General hazard.</p>
	<p>Electric shock hazard. To avoid personal injury, disconnect all power sources before performing maintenance or service.</p>
	<p>Electrocution hazard. To avoid personal injury, always disconnect all power sources before performing maintenance or service procedures.</p>
	<p>Fire hazard. To avoid personal injury and property damage, follow the instructions provided in this document.</p>
	<p>Hot surface hazard. To avoid personal injury, allow the product to cool for the recommended cool down time before performing maintenance or service.</p>
	<p>Burn hazard. To avoid personal injury, allow the product to cool for the recommended cool down time before performing maintenance or service.</p>
	<p>Moving parts hazard. To avoid personal injury, keep hands clear and loose clothing tied back.</p>
	<p>Fan hazard. To avoid personal injury, keep hands clear and loose clothing tied back. Always disconnect all power sources before performing maintenance or service procedures.</p>
	<p>Voltage hazard. To avoid personal injury, always disconnect all power sources before performing maintenance or service procedures.</p>
	<p>Not for household use.</p>

Mandatory action



Consult the service manual.



Disconnect all power sources before performing maintenance or service procedures.

Electrical labels



Indicates the presence of an earth ground.

Laser labels

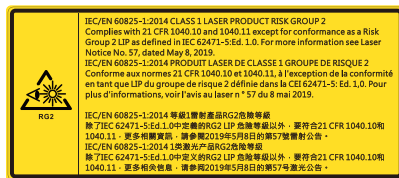

This projector has been classified as Class 1 Laser Product-Risk Group 2 according to the IEC 60825-1:2014 and IEC 62471- 5:2015 standard.

Indicates a light hazard. Do not look directly into the lens. The extreme high brightness can cause permanent eye damage.

Class 1 Laser Product-Risk Group 2 according to Class 1 IEC 60825-1:2014 and IEC 62471-5:2015.



Mount above the heads of children. When within 1 m of the product, avoid eye exposure to avoid temporary or permanent eye damage.

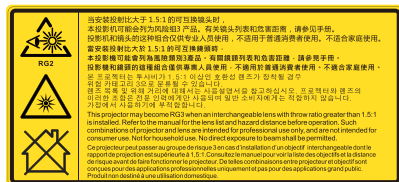

4K22-HS and 4K22A-HS may become RG3 when an interchangeable lens with throw ratio greater from 1.5-2.0: 1 is installed.

4K13-HS and 4K13A-HS may become RG3 when an interchangeable lens with throw ratio greater from 2.0-4.0: 1 is installed.

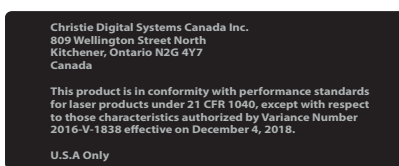

FDA laser variance (US projectors only).

This product is in conformity with performance standards for laser products under 21 CFR 1040, except with respect to those characteristics authorized by Variance Number 2016-V-1838 effective on December 4, 2018.

Additional safety hazard



Do not look directly into the lens. The extremely high brightness can cause permanent eye damage.

Projector overview

The HS Series 4K is a high brightness, high-resolution video graphics one-chip laser-based projector. The projector is available in 4K resolution and uses Digital Light Processing (DLP™) technology from Texas Instruments. It is primarily designed for fixed installation and secondary applications including rental-staging and LBE (Location Based Entertainment). This product is used for professional applications and is not for domestic use.

Contact your dealer

Record the information about your projector and keep this information with your records to assist with the servicing of your projector. If you encounter a problem with your Christie projector, contact your dealer.

Purchase record	
Dealer:	
Dealer or Christie Sales/Service contact phone number:	
Projector serial number:	
The serial number can be found on the license label located on the display panel	
Purchase date:	
Installation date:	

Ethernet settings	
Default gateway	
Projector IP address	
Subnet mask	

Key features

- 4K 3840 x 2160 resolution
- High picture quality with superb brightness performance
- Lens suite options for installation flexibility
- Powered lens adjustment with lens memory function
- Projection lens compatibility:
 - 360 degrees projection
 - 3D blending and auto warping
 - Supports fog filter as an optional accessory
- Full HD 3D technology with frame sequential up to 120 Hz
- Support 4K 3D dual pipe

- Support 1920 x 1080@240Hz
- Christie Twist™ and Mystique™ allows for easy and quick blending and warping. Support for Mystique™ camera based alignment system (sold separately)
- A wide range of connectivity including HDMI, HDBaseT, and 3D inputs
- Integrated HDBaseT solution supports 4K video streaming through RJ45
- SNMP traps and email notifications
- 10-bit image processor electronics with modular design
- All video formats can be resized to full screen either horizontally or vertically while maintaining aspect ratio.
- The projector can be operated using any of the following:
 - The built-in keypad, the infrared (IR) remote keypad, a wired remote keypad, or a PC/ device using serial communications (Ethernet or RS232)
 - A web page using Ethernet, or from a PC or device using a wireless USB dongle (optional)

How the projector works

The HS Series 4K projectors accept a variety of input signals for a wide range of commercial projection applications.

Designed with solid-state illumination light sources and phosphor technology, the red, green and blue color elements are segmented through a phosphor wheel and modulated by one Digital Micromirror Device (DMD) panel responding to incoming data streams of digitized red, green, and blue color information. As these digital streams flow from the source, light from the responding on pixels of the DMD panel is reflected, converged, and projected to the screen through projection lenses, where all pixel reflections are superimposed in sharp full-color images.

List of components

This projector comes with all the items listed below. Check to make sure your package is complete. If anything is missing, contact your dealer.

- AC power cord
- IR remote keypad
- Product Safety Guide

Product documentation

For installation, setup, and user information, see the product documentation available on the Christie Digital Systems USA Inc. website at www.christiedigital.com. Read all instructions before using or servicing this product.

1. Access the documentation from the Christie website:
 - Go to this URL: <http://bit.ly/2JtghsE> or <https://www.christiedigital.com/en-us/business/products/projectors/1-chip-dlp/hs-series>
 - Scan the QR code using a QR code reader app on a smartphone or tablet.



2. On the product page, select the model and switch to the **Downloads** tab.

Related documentation

Additional information on the projector is available in the following documents.

- *HS Series 4K Installation and Setup Guide (P/N: 020-002055-XX)*
- *HS Series 4K Product Safety Guide (P/N: 020-002052-XX)*
- *HS Series 4K Service Manual (P/N: 020-002054-XX)*
- *HS Series 4K Serial Commands Technical Reference (P/N: 020-103737-XX)*
- *Twist User Guide (P/N: 020-101380-XX)*
- *Mystique Operate Instruction Sheet (P/N: 020- 102382-XX)*

Technical support

Technical support for Christie Enterprise products is available at:

- North and South America: +1-800-221-8025 or Support.Americas@christiedigital.com
- Europe, Middle East, and Africa: +44 (0) 1189 778111 or Support.EMEA@christiedigital.com
- Asia Pacific (support.apac@christiedigital.com):
 - Australia: +61 (0)7 3624 4888 or tech-Australia@christiedigital.com
 - China: +86 10 6561 0240 or tech-supportChina@christiedigital.com
 - India: +91 (80) 6708 9999 or tech-India@christiedigital.com
 - Japan: 81-3-3599-7481

- Singapore: +65 6877-8737 or tech-Singapore@christiedigital.com
- South Korea: +82 2 702 1601 or tech-Korea@christiedigital.com
- Christie Professional Services: +1-800-550-3061 or NOC@christiedigital.com

Additional information

Lens type for 4K (4K22-HS, 4K22A-HS, 4K13-HS, 4K13A-HS).

Lens type	140-142108-XX	140-144100-XX	140-159106-XX	140-115108-XX	140-158105-XX	140-109101-XX	140-110103-XX	140-111104-XX
Throw Ratio	0.38	0.65 - 0.75	0.75 - 1.08	1.02 - 1.36	1.08 - 1.5	1.2 - 1.5	1.5 - 2.0	2.0 - 4.0
Projection Lens	Ultra Short Throw	Short Throw	Short Throw	Wide Zoom	Wide Zoom	Wide Zoom	Standard	Long Zoom
Zoom Ratio	No Zoom	1.15X	1.44X	1.33X	1.38X	1.25X	1.33X	2X

Lens type	140-116109-XX	140-145101-XX
Throw Ratio	4.0 - 7.2	7.2 - 10.8
Projection Lens	Ultra-Long Zoom	Ultra-Long Throw
Zoom Ratio	1.8X	1.5X

Installation and setup

Learn how to install, connect, and optimize the projector display.

Site requirements

To safely install and operate the projector, the installation location must have restricted access for authorized personnel only and meet these minimum requirements.

Physical operating environment

Provides specifications for the operating environment.

Item	Specification
Ambient temperature (operating)	0 to 40°C (32 to 104°F) for 0 to 762 meters (0 to 2500 feet)
	0 to 35°C (32 to 95°F) for 762 to 1524 meters (2500 to 5000 feet)
	0 to 30°C (32 to 86°F) for 1524 to 3048 meters (5000 to 10,000 feet)
Storage temperature range	-10 to 60°C (14 to 140°F)
Humidity range	10% to 85% RH (maximum), non condensing
Storage humidity range	5% to 90% RH (maximum), non condensing
Operating altitude	3048 meters (10,000 feet) maximum

Power connection

The projector uses an AC power system allowing the projector to operate at full brightness with a power supply of 100 to 240 VAC. Operating the device outside of the voltage range may cause unsatisfactory operation or damage to the projector. To ensure safety operation, only use the AC power cord provided with the product or recommended by Christie.

Model name	Power requirements
4K13-HS, 4K13A-HS	<ul style="list-style-type: none"> • 100-240 VAC, 50/60Hz, 11 A • 100-120 VAC, 50/60Hz, 11 A • 220-240 VAC, 50/60Hz, 5 A
4K22-HS, 4K22A-HS	<ul style="list-style-type: none"> • 100-240 VAC, 50/60Hz, 13.5 A • 100-120 VAC, 50/60Hz, 13.5 A • 220-240 VAC, 50/60Hz, 8.5 A

Projector components

Identify the main components of the projector.

Front view

Identify the main components on the front of the projector.

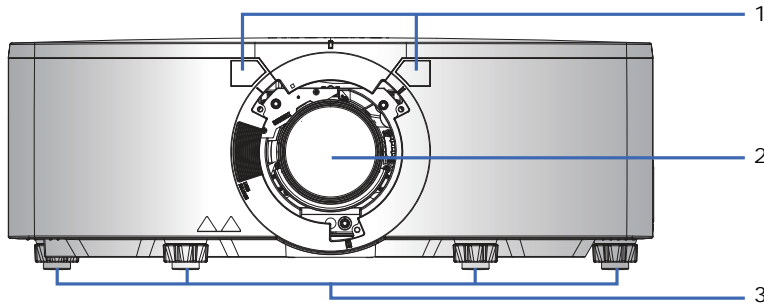

ID	Part name	Description
1	Front IR sensor	Receives signals from the IR remote keypad. Keep the signal path to the sensor unobstructed for uninterrupted communication with the projector.
2	Projection lens	Allows automated lens control and adjustment: vertical and horizontal offsets, zoom, and focus.
3	Adjustable feet	Raises or lowers the feet to level the projector.

Rear view

Identify the main components on the rear of the projector.

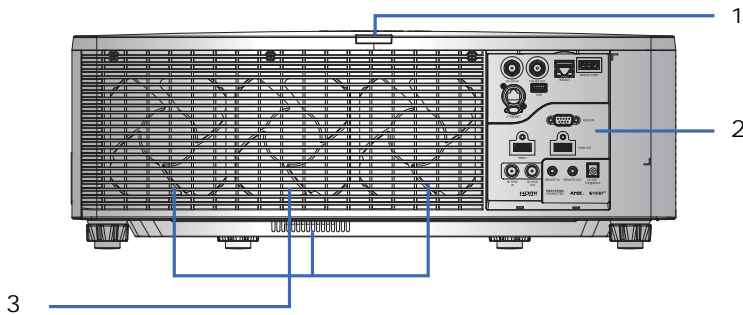

ID	Part name	Description
1	Rear IR sensor	Receives signals from the IR remote keypad. Keep the signal path unobstructed for uninterrupted communication with the projector.
2	Input/Output (I/O) panel	Connects the projector to external devices.
3	Cooling air vents (exhaust)	Provides cooling to the projector. Keep these vents unobstructed to prevent the projector from overheating.

Left view

Identify the main components on the left side of the projector.

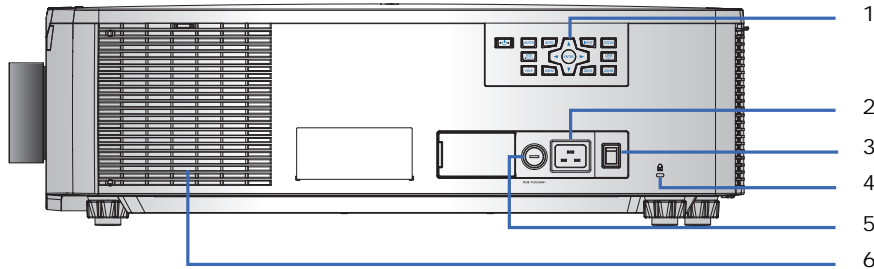

ID	Part name	Description
1	Built-in keypad	Controls the projector.
2	AC input	Connects to the supplied power adapter.
3	Power button	Powers the projector on or off.
4	Kensington lock	Secures the projector to counter tops, tables, and so on.
5	Fuse	<ul style="list-style-type: none"> • 4K13-HS/4K13A-HS: T15A/250VAC • 4K22-HS/4K22A-HS: T20A/250VAC
6	Cooling air vents (intake)	Provides cooling to the projector. Keep these vents unobstructed to prevent the projector from overheating.

Right view

Identify the main component on the right side of the projector.

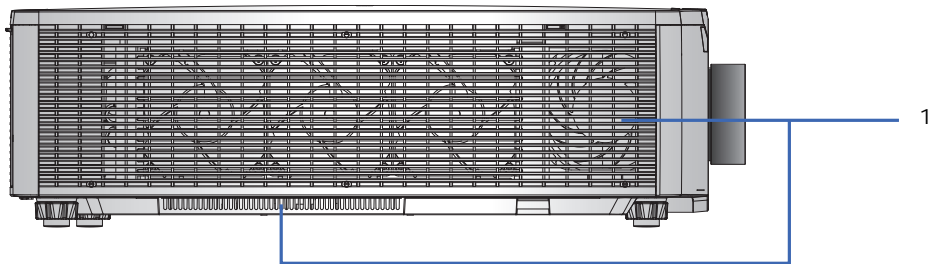

ID	Part name	Description
1	Cooling air vents (intake)	Provides cooling to the projector. Keep these vents unobstructed to prevent the projector from overheating.

Built-in keypad

The built-in keypad controls the projector.

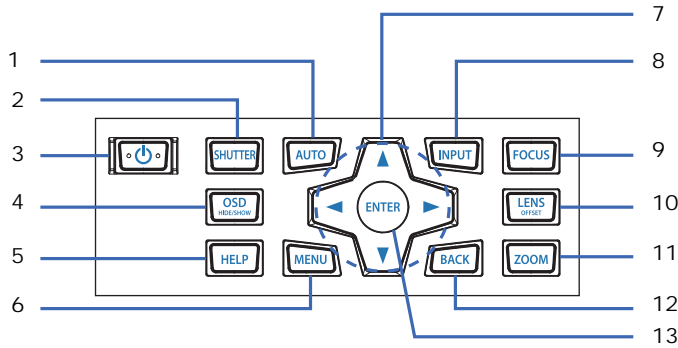

ID	Button	Description
1	AUTO	Automatically optimizes an image.
2	SHUTTER	Displays or blanks the video image.
3	POWER	Turns the projector on or off.
4	OSD HIDE/SHOW	Hides or shows the on-screen display (OSD) menus.
5	HELP	Displays the instructions for source connection.
6	MENU	Displays the menus.
7	Arrow Keys	Adjusts a setting up or down, or navigate within a menu.
8	INPUT	Selects an input for the main or picture in picture/picture by picture (PIP/PBP) image.
9	FOCUS	Adjusts the focus.
10	LENS OFFSET	Adjusts the lens vertical or horizontal offset setting.
11	ZOOM	Adjusts the zoom.
12	BACK	Returns to the previous level or exits the menus if at top level.
13	ENTER	Confirms the item selection.

Input/output (I/O) panel

Identify the components of the Input/Output (I/O) panel.

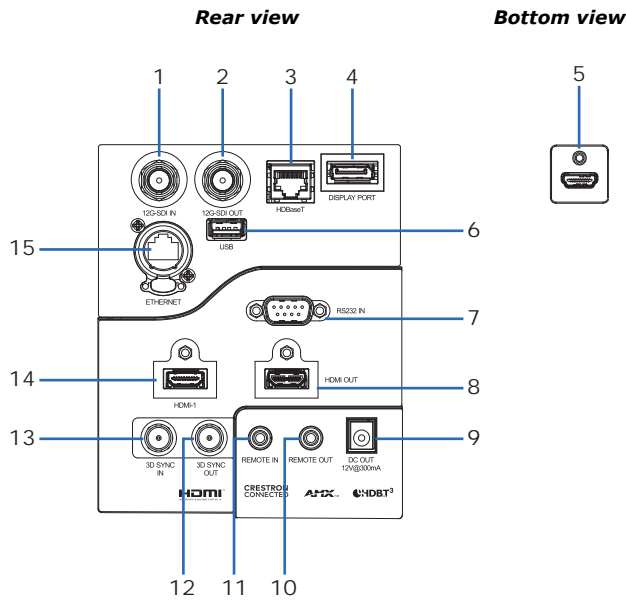

ID	Connector name	ID	Connector name
1	12G-SDI IN	9	DC OUT
2	12G-SDI OUT	10	REMOTE OUT
3	HDBaseT	11	REMOTE IN
4	DISPLAY PORT	12	3D SYNC OUT
5	HDMI-2	13	3D SYNC IN
6	USB (5 V/500 mA)	14	HDMI-1
7	RS232 IN	15	ETHERNET (10/100 Mbps)
8	HDMI OUT		

IR remote keypad

The IR remote keypad communicates with the projector by way of wireless communications.

If you choose to use a cable, not supplied, it must be 20 m (65.6 feet) or less. If the length of cable exceeds 20 m (65.6 feet), the IR remote keypad may not work correctly.

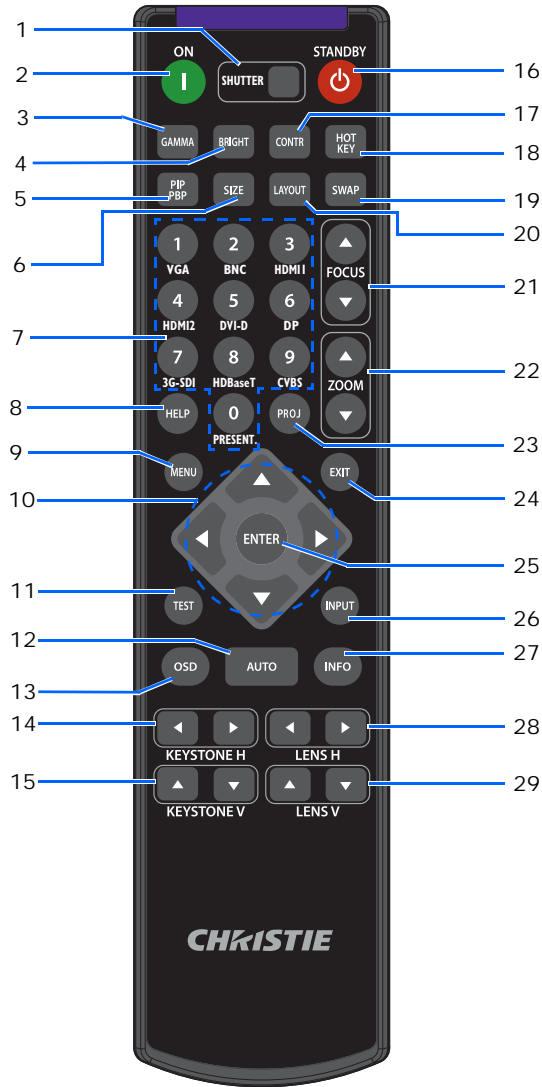

ID	Button	Description
1	SHUTTER	Displays or blanks the video image.
2	ON	Turns the projector on.
3	GAMMA	Adjusts the mid-range levels.
4	BRIGHT	Adjusts the amount of light in the image.

ID	Button	Description
5	PIP PBP	Turns picture-in-picture/picture-by-picture (PIP/PBP) on or off.
6	SIZE	Adjusts the PIP/PBP size.
7	Number Keys	Enter a number, such as a channel, value, and so on. The on-screen display (OSD) indicates if a function is not supported.
8	HELP	Displays the instructions for source connection.
9	MENU	Displays the menus.
10	Arrow Keys	Adjusts a setting up or down to navigate within a menu.
11	TEST	Displays a test pattern.
12	AUTO	Automatically optimizes an image.
13	OSD	Hides or shows OSD menus.
14	KEYSTONE H	Adjusts the horizontal keystone.
15	KEYSTONE V	Adjusts the vertical keystone.
16	STANDBY	Turns the projector off.
17	CONTR	Adjusts the difference between dark and light.
18	HOT KEY	Selects your preset key quickly.
19	SWAP	Swaps the main and PIP/PBP images.
20	LAYOUT	Adjusts the PIP/PBP layout.
21	FOCUS	Adjusts the focus to improve image clarity as required.
22	ZOOM	Adjusts the zoom to achieve a required image size.
23	PROJ	Changes the IR remote keypad ID. <ul style="list-style-type: none"> • To assign an ID, select PROJ + <1 to 9>. • To return to the universal IR remote ID, select PROJ + 0.
24	EXIT	Returns to the previous level or exits menus if at the top level.
25	ENTER	Selects a highlighted menu item, or changes or accepts a value.
26	INPUT	Selects an input for the main or PIP/PBP image.
27	INFO	Displays the projector information.
28	LENS H	Adjusts the position of the image horizontally.
29	LENS V	Adjusts the position of the image vertically.

Positioning the display

When you select a position for the projector, consider the size and shape of your screen, the location of your power outlets, and the distance between the projector and the rest of your equipment. Follow these general guidelines:

- Position the projector on a flat surface at a right angle to the screen. The projector (with the standard lens) must be at least 1.6 m (5.2 feet) from the projection screen.
- Position the projector to the required distance from the screen. The distance from the lens of the projector to the screen, the zoom setting, and the video format determine the size of the projected image.
- Determine the lens throw ratio.
For more information detailing the throw ratio for each lens, refer to the *HS Series 4K Lens Throw Ratios Technical Reference (P/N: 020-103738-XX)*.
- 360 degree free orientation operation

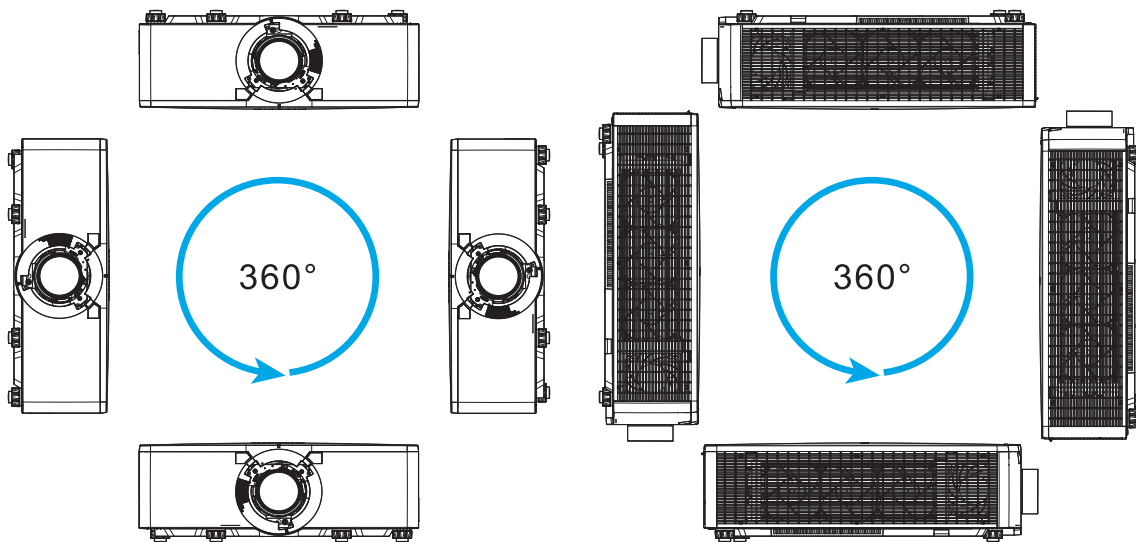

When installing the projector in portrait orientation, Christie recommends the built in keypad and power inputs face upwards. This allows access to the built in keypad and power connections during operation.

Turning on the projector

The projector cables must be securely connected before turning the power on.



Warning! Failure to comply with the following could result in death or serious injury.

- Do not look into the projector lens when the laser is on. The bright light may result in permanent eye damage.
- Installing or replacing a lens must be done by a Christie-qualified service technician to avoid exposure to dangerous emission levels.

1. Plug the projector in to AC power.

The Power button on the built in keypad is illuminated when the power cables are connected.

2. Ensure the lens has been installed in the projector by a Christie-qualified service technician.
3. Ensure no one or no objects are in the beam path before turning on the projector.
4. To turn on the projector, on the IR remote keypad on the built-in keypad select .

The status LED is green with a long blink.

5. To select an input source and turn it on, on the IR remote keypad select **INPUT**.

Available input sources are HDMI1, HDMI2, Display Port, 12G-SDI, and HDBaseT.

The projector detects the source you selected and displays the image.

6. If using the projector for the first time, select a preferred language from the Main Menu after the startup screen is displayed.

Turning off the projector

Power off the projector in preparation for inspection or maintenance.

1. To turn the projector off, on the IR remote keypad or built-in keypad select .

A warning message appears on the displayed image.

2. To confirm your selection, select  again.

If you do not select  again, the warning message disappears after three seconds and the projector remains on.

LED status indicator

LED status indicator helps identify the projector state. LEDs are defined below.

Status LED

Identify the LED state colors and meaning.

LED status	Projector state
Off	AC power is off (without AC plugged in).
Green (flashing)	Projector is starting up.
Green (solid)	System is operating normally.
Blue (flashing)	Projector is cooling down.
Blue (solid)	Projector is in standby mode.
Yellow (flashing)	A problem exists with the projector that does not cause it to shut down. Examples of warnings include: filter needs changing, one of the pumps is damaged, or a fan is operating at full speed due to over temperature of laser diode (LD) driver.
Yellow (solid)	The end user is turning off the projector while it is in a warning state.
Red (flashing)	An error with the projector exists causing it to shut down. Examples of errors include: fan failure, over temperature, wrongly installed filter, or color wheel (CW) failure.
Red (solid)	The user is turning off the projector while it is in an error state.
White (flashing)	Projector is in Firmware Upgrade Mode.

Shutter LED

Identify the shutter LED state colors and meaning.

LED status	Projector state
Off	Projector is on and an image is displayed. Shutter is open.
Magenta (solid)	Projector is on and the image is blank. Shutter is closed.

Adjusting the size and position

Adjust the projector's size and position. Christie recommends warming the lens before completing these procedures as focus may change as the lens warms.

Setting the image size preset

Set the image size preset to display the image in its native resolution or to resize by maximizing the height, width, both height and width, or to the maximum size while keeping the original aspect ratio.

1. Select **Menu > Size & Position > Size Presets**.
2. Select the appropriate size preset:
 - **Auto**—Displays with the detected size.
 - **Native**—Displays in its native resolution.
 - **4:3**—Retains 4:3 aspect ratio.
 - **Letterbox**—Makes the active content enlarge to the full screen.
 - **Full Size**—Fills the screen, regardless of the source.
 - **Full Width**—Fills display width and keep aspect ratio.
 - **Full Height**—Fills display height and keep aspect ratio.
 - **Custom**—Stretches the display horizontally and vertically without cutting the image display.
 - **3D Mode**—Displays 3D content. All other items are grayed out, if 3D Mode is selected.
3. To confirm the selection, select **ENTER**.

Setting the digital size of display image

These functions are similar technologies as in-camera image processing. Use Digital Horz Zoom or Digital Vert Zoom to enlarge or to compress the display image horizontally or vertically.

1. Select **Menu > Size & Position > Digital Horz Zoom** or **Digital Vert Zoom**.
2. Adjust the slider by arrow keys or select **ENTER** to input the value you selected.
3. After inputting the value, select **ENTER** to apply.

Setting the digital position of display image

Change the position of the projector's display image horizontally or vertically.



Digital Horz Shift is only available after adjusting the Digital Horz Zoom, and Digital Vert Shift is only available after adjusting the Digital Vert Zoom.

1. Select **Menu > Size & Position > Digital Horz Shift** or **Digital Vert Shift**.
2. Adjust the slider by arrow keys or select **ENTER** to input the value you selected.
3. After inputting the value, select **ENTER** to apply.

Geometry correction

Modify the geometry of the display image directly on the projector.

Connecting to Christie Twist and Mystique grays out the geometry correction settings on the projector. Uploading warp and blend from Twist and Mystique overwrites the currently applied geometry correction settings. See [Configuring warp and blend](#) on page 34 for more details.

Enabling geometry correction

Enable or disable the geometry correction function including Warp, Blend, Keystone, Pincushion, 4-Corner, Auto Warp Filter, and Manual Warp Filter.

1. Select **Menu > Size & Position > Geometry Correction > Geometry Enable**.
2. To enable the setting, select **ENTER**.

Saving geometry correction

Save the warp and blend settings to the projector memory. The blend memory saves the edge blend settings, while the warp memory saves the settings of Keystone, Pincushion, 4-Corner, Manual Warp Filter, and image warp.

1. Select **Menu > Size & Position > Geometry Correction > Warp Memory > Save Warp** or **Blend Memory > Save Blend**.
2. To save the geometry setting, select a record.
One projector can save up to four warps and four blends.
3. To confirm the selection, select **ENTER**.

Applying geometry correction

Apply the previously saved geometry setting to the projector.

1. Before applying the previous geometry setting, save the geometry setting to the projector.
See [Saving geometry correction](#) on page 29 for further information.
2. Select **Menu > Size & Position > Geometry Correction > Warp Memory > Apply Warp** or **Blend Memory > Apply Blend**.
3. To apply the specific geometry setting, select the required record.
4. To confirm the selection, select **ENTER**.
5. To erase the applied geometry setting, select **Off**.

Enabling basic image blending

Configure blends directly on the projector to increase or decrease the borders of an individual image, so it blends with a neighboring image to create a single, seamless image.

You can set blends on a projector when not using Christie Twist and Mystique. Connecting to Twist and Mystique grays out the blend settings on the projector. Applying blends from Twist and Mystique overwrites the blends directly set on the projectors.

1. Select **Menu > Size & Position > Geometry Correction > Blend Area**.
2. Choose a side to blend in with the other projectors.
3. To set up the starting position, select **Start Pixel**.
4. Adjust the slider by arrow keys or select **ENTER** to input the starting position.
5. After inputting the starting position, select **ENTER**.
6. To set up the size of blend area, select **Pixel Height**.
7. Adjust the slider by arrow keys or select **ENTER** to input the width of blend area.
8. After inputting the size of blend area, select **ENTER**.
9. To set the gamma value of the blend area, select **Blend Gamma**.
10. After selecting a gamma value, select **ENTER**.
11. To apply the settings, select **Enable**.
12. Select **ENTER**.
13. To save the blend setting, select **Menu > Size & Position > Geometry Correction > Blend Memory > Save Blend**.
14. To set up the other side of blend area, repeat step 2 to 13.

Blending multiple images

Use Christie Twist to manually configure edge blends and apply them to the projectors.

Christie Twist Premium and Twist Pro offer advanced blending options. Refer to the Christie website (www.christiedigital.com) for product information and documentation.

1. Connect the projector and computer to the same network and subnet.
2. To add a projector to a computer, from the Twist menu, select **Home > Add**.
 - To manually connect the projector with Twist, use port 3003.
 - Connecting to Twist grays out the Geometry Correction settings on the projector.
3. Select a record number to save the blend setting.

You can save up to four blend settings.

4. In Twist, configure edge blend settings.

Use the test patterns in Twist to assist in adjusting the blend area.

For more information about creating blend files in Twist, refer to *Twist User Guide (P/N: 020-101380-XX)*.

5. To send the blend settings to the projector, on the canvas, right-click a projector window and select **Send Blend**.
6. Repeat step 2 to 5 for the remaining projectors.

For multiple projectors, use Twist to identify the projectors.
7. To save the warp file on the projector, select **File > Save** or **Save As**.

When removing the projector from Twist, or closing the program, the projector automatically saves the currently applied blend settings to its blend memory.
8. To change the name when saving blends on the projector, or update the memory location of the blend, select **Properties**.

The changed name shows on both Twist and the projector.

Downloading a blend from the projector memory

Use Twist to download the blend file saved on the projector memory.

1. Before downloading the previous blend file, save the blend setting to the projector memory.
2. On the canvas, click a projector window.
3. Select **File > Blend/Mask/B.U**.
4. In the **Download Blend** dialog, select the required record.
5. To download the selected blend setting, select **OK**.
6. To apply the blend setting to the projector, on the canvas, right-click a projector window and select **Send Blend**.

Adjusting horizontal keystone

Use horizontal keystone to correct a keystone image shape in which the left and right borders of the image are unequal in length, and the top and bottom are slanted to one of the sides.

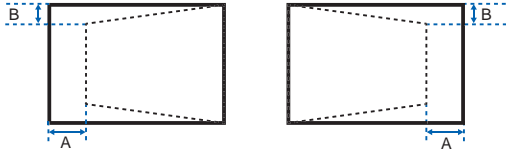

1. Select **Menu > Size & Position > Geometry Correction > Keystone > Horz Keystone**.
2. To adjust the horizontal keystone, adjust the slider by arrow keys or select **ENTER** to input the value you selected.
3. After inputting the value, select **ENTER** to apply.

Adjusting the vertical keystone

Use vertical keystone to correct a keystone image shape in which the top and bottom borders of the image are unequal in length, and both sides of the image are inclined toward the top or bottom edge.

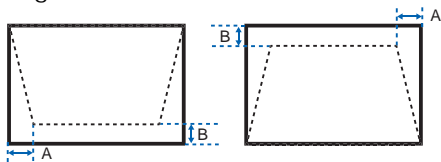

1. Select **Menu > Size & Position > Geometry Correction > Keystone > Vert Keystone**.
2. To adjust the vertical keystone, adjust the slider by arrow keys or select **ENTER** to input the value you selected.
3. After inputting the value, select **ENTER** to apply.

Adjusting horizontal pincushion

Use horizontal pincushion to correct a pinched image shape in which the horizontal straight lines are curved inwards or horizontal straight lines are curved outwards from the center.

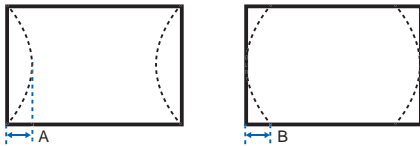

1. Select **Menu > Size & Position > Geometry Correction > Pincushion > Horz Pincushion**.
2. To adjust the horizontal pincushion, adjust the slider by arrow keys or select **ENTER** to input the value you selected.
3. After inputting the value, select **ENTER** to apply.

Adjusting vertical pincushion

Use vertical pincushion to correct a pinched image shape in which the vertical straight lines are curved inwards or vertical straight lines are curved outwards from the center.

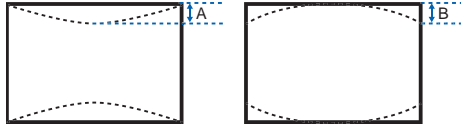

1. Select **Menu > Size & Position > Geometry Correction > Pincushion > Vert Pincushion**.
2. To adjust the vertical pincushion, adjust the slider by arrow keys or select **ENTER** to input the value you selected.
3. After inputting the value, select **ENTER** to apply.

Adjusting 4-corner

Use 4-corner to correct the four corners of the projector's display image.

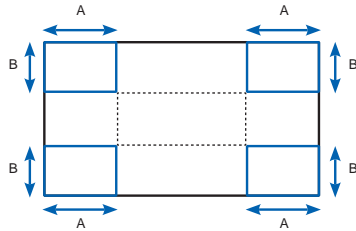

1. Select **Menu > Size & Position > Geometry Correction > 4-Corner**.
2. Select the corner and the direction to adjust.
3. To move the corner, adjust the slider by arrow keys or select **ENTER** to input the value.
4. After inputting the value, select **ENTER** to apply.
5. To adjust the other corner or direction, repeat step 2 to 4.

Enabling auto warp filter

Improve the sharpness of the image and reduce the ghosting automatically after geometry correction, such as keystone, pincushion, 4-corner, and warping.

1. Select **Menu > Size & Position > Geometry Correction > Auto Warp Filter**.
2. To enable the setting, select **ENTER**.

Adjusting warp filter

Improve the sharpness of the image after geometry correction, such as keystone, pincushion, 4-corner, and warping. Adjust the warp filter manually to reduce the ghosting.

1. Select **Menu > Size & Position > Geometry Correction > Manual Warp Filter**.
2. To reduce the ghosting in different direction, select **Horz Filter** or **Vert Filter**.
3. Adjust the slider by arrow keys or select **ENTER** to input the value.
4. After inputting the value, select **ENTER** to apply.

Resetting geometry correction setting

Reset all geometry correction parameters back to default, including warp and blend settings.

1. Select **Menu > Size & Position > Geometry Correction > Reset to Default**.
2. Select **ENTER**.

Configuring warp and blend

By blending multiple images, you can combine several projectors to create a larger and seamless image. When the projection screen is not perfectly flat or rotated at an angle, warp the image to fit on the irregular surface.

Warping an image

Christie Twist offer various manual warping options to adjust the image shape with minimal performance impact. Refer to the Christie website (www.christiedigital.com) for product information and documentation.



Christie Twist can be upgraded to Twist Premium and Twist Pro that provides more advanced warping features. Refer to the Christie website (www.christiedigital.com) for product information and documentation.

1. Connect the projector and computer to the same network and subnet.
2. To add a projector to a computer, from the Twist menu, select **Home > Add**.
 - To manually connect the projector with Twist, use port 3003.
 - Connecting to Twist grays out the Geometry Correction settings on the projector.

3. Select a record number to save the warp.

You can save up to four warp settings.

4. In Twist, configure warp settings.

Use the test patterns in Twist to help with image shaping.

For more information about creating warp files in Twist, refer to *Twist User Guide (P/N: 020-101380-XX)*.

5. To send the warp settings to the projector, on the canvas, right-click a projector window and select **Send Warp**.

6. To save the warp settings on the projector, select **File > Save** or **Save As**.

When removing the projector from Twist, or closing the program, the projector automatically saves the currently applied warp settings to its warp memory.

7. To change the name when saving warps on the projector, or update the memory location of the warp, select **Properties**.

The changed name shows on both Twist and the projector.

Downloading a warp from the projector memory

Use Twist to download the warp file saved on the projector memory.

1. Before downloading the previous warp file, save the warp setting to the projector memory.
2. On the canvas, click a projector window.
3. Select **File > Warp**.
4. In the Download from Memory Location list, select the required record.
5. To download the selected warp setting, select **OK**.
6. To apply the warp setting to the projector, on the canvas, right-click a projector window and select **Send Warp**.

Performing auto warp and blend

Use Mystique (sold separately) to perform automatic warp, blend, and more advanced geometry settings. Mystique is an automated camera-based alignment and recalibration solution that lets you quickly stage, install, align, calibrate, and maintain multi-projection systems.

Refer to the Christie website (www.christiedigital.com) for product information and documentation.

Adjusting the image settings

Learn how to adjust the projector image.

Adjusting the brightness

Adjust the intensity of the image.

1. Select **Menu > Image Settings > Brightness**.
2. Adjust the slider by arrow keys or select **ENTER** to input the value.
3. After inputting the value, select **ENTER** to apply.

Adjusting the contrast

Adjust the degree of difference between the lightest and darkest parts of the image and changes the amount of black and white in the image.

1. Select **Menu > Image Settings > Contrast**.
2. Adjust the slider by arrow keys or select **ENTER** to input the value.
3. After inputting the value, select **ENTER** to apply.

Adjusting the color space

Determine how the color components are decoded for accurate color in the display.

1. Select **Menu > Image Settings > Color Space**.
2. If projector does not detect the correct input signal while **Auto** is enabled, disable **Auto** by selecting **ENTER** to select color space manually.
3. To match up with the input signal, select appropriate color space:
 - Auto
 - RGB

- RGB Full
 - RGB Limited
 - YUV
 - REC709
 - REC601
4. To confirm the selection, select **ENTER**.

Adjusting the image sharpness

Adjust the edge clarity of the image.

1. Select **Menu > Image Settings > Detail**.
2. Select the sharpness:
 - Maximum
 - High
 - Normal
3. To confirm the selection, select **ENTER**.

Setting up 3D display

Use the functions in 3D Display menu to make the timing adjustment and environment necessary for displaying 3D images.

Setting 3D mode

Set up the 3D mode according to the 3D input signal.

1. Select **Menu > Image Settings > 3D Display > 3D Mode**.
2. Select the appropriate 3D mode:
 - Active 3D
 - Passive 3D
3. To confirm the selection, select **ENTER**.

Setting 3D format

Set up the 3D format according to the 3D input signal.



- Projecting the image in 4K 3D/4K 3D Dual Pipe format may display a few jitter effects. This is considered as a normal behavior.
- 4K 3D Dual Pipe has limited warping options when processing image distortion correction such as keystone and pincushion.
- 4K 3D/4K 3D Dual Pipe format is supported only with HDMI 1 and HDMI 2 sources.

1. Select **Menu > Image Settings > 3D Display > 3D Enable**.
2. Select the appropriate 3D format:
 - Auto
 - Frame Packing
 - Side by Side
 - Top and Bottom
 - Frame Sequential
 - Dual Pipe
 - 4K 3D
 - 4K 3D Dual Pipe
 - Off
3. To confirm the selection, select **ENTER**.

Inverting 3D signal

3D images consist of a series of images (frames) that alternate quickly between two slightly different view points, corresponding to our left and right eyes. When these frames are displayed fast enough and viewed with 3D glasses synchronized to the left/right (L/R) changes, the resulting image appears with the same depth and perspective that is sensed in the real world.

If the projector generates the sync internally and content is displayed without 3D sync in the cable connected to the projector, the content has a 50% chance of being displayed with the left/right eyes swapped. This function is used for swapping the sequence of the image to make the resulting image appear normally.

1. Select **Menu > Image Settings > 3D Display > 3D Invert**.
2. To swap, select **ENTER**.

Selecting the 3D sync input signal

This function is used for selecting the 3D sync input option.

1. Select **Menu > Image Settings > 3D Display > 3D Sync In Select**.
2. Select the appropriate 3D sync in setting.
 - **Auto**—If an external 3D sync input is detected, the projector uses automatically the external sync input. If no external sync input is detected, the projector uses the internal 3D sync to display the content.
For multi-threaded applications, if the 3D enable function is set to Frame Sequential, Christie recommends to connect the source device to the projector using 3D Sync In port. The Frame Delay function makes sure a synchronized display for multiple projectors.
 - **Internal**—The projector generates the 3D sync internally and content is displayed.
 - **External**—The projector uses an external 3D sync input to display the content.
3. To confirm the selection, select **ENTER**.

Setting the 3D sync output signal

This function is used for controlling and processing the 3D sync output signal.

1. Select **Menu > Image Settings > 3D Display > 3D Sync Out**.
2. Select the appropriate 3D sync out setting.
 - **To Emitter**—If the 3D sync out port is connected to an emitter, select **To Emitter** to transmit 3D signal to emitter and give to 3D glasses.
 - **To Next Projector**—Multiple projectors 3D application only. Select **To Next Projector** when the 3D sync out port is not connected to an emitter.
3. To confirm the selection, select **ENTER**.

Setting the frame delay

Adjust the frame delay output through the projector.

It will introduce some delay, typically used in multi-machine synchronization for delay alignment.

1. Select **Menu > Image Settings > 3D Display > Frame Delay**.
2. Adjust the slider by arrow keys or select **ENTER** to input the value.
3. After inputting the value, select **ENTER** to apply.

Setting the sync delay

Adjust the sync delay which eliminates the odd colors and cross talk caused by timing difference. Sync delay is the time difference between the first 3D signal being given and the result being executed from the current projector.

1. Select **Menu > Image Settings > 3D Display > Sync Delay**.
2. Adjust the slider by arrow keys or select **ENTER** to input the value.
3. After inputting the value, select **ENTER** to apply.

Configuring the video settings

Configure the video settings to optimize the image performance, such as applying color to black and white videos, reducing luminance component noise, and so on.

Adjusting black and white video

Adjust a video image from black and white to fully saturated color. This feature is for video sources only.

1. Select **Menu > Image Settings > Video Options > Color**.
2. Adjust the slider by arrow keys or select **ENTER** to input the value.
3. After inputting the value, select **ENTER** to apply.

Adjusting the color balance

Adjust the red-green color balance in NTSC video images. NTSC, named after the National Television System Committee, is the analog video color system used in North America and most of the South America countries. This feature is for NTSC video sources only.

1. Select **Menu > Image Settings > Video Options > Tint**.
2. Adjust the slider by arrow keys or select **ENTER** to input the value.
3. After inputting the value, select **ENTER** to apply.

Configuring picture settings

Depending on display content, choose the most suitable picture settings. Different picture settings have different color temperature, brightness, and so on.

1. Select **Menu > Image Settings > Picture Settings**.
2. Select the appropriate picture setting:
 - **Video**—Used for theater application. It sets the color temperature to 6000K with 70% of maximum brightness.
 - **Bright**—Used for large size or high brightness application. It sets the color temperature to 7500K with 100% brightness.
 - **Enhanced**—Used for images with richly saturated and vivid color. It is based on brightness mode.
 - **REC709**—Used for high-definition television. It sets the color temperature to 6500K with 80% of the maximum brightness.
 - **DICOM SIM**—Used for high contrast content, such as X-ray diagram. It sets the color temperature to 7500K with 65% brightness.
 - **Blending**—Used for multiple projector application. It sets the color temperature to 7000K with 85% of maximum brightness.
 - **HDR**—Used for displaying high dynamic range content for deepest blacks, brightest whites, and vivid cinematic color using REC.2020 color gamut.
 - **3D**—Used to display the 3D content. For more information on configuring 3D settings, see [Setting up 3D display](#) on page 37.
 - **High Frame Rate**—Used for displaying 2D input signal at 240Hz.
 - **User**—Customized picture setting. See [Editing customized picture setting](#) on page 41 for further details of creating a customized picture setting.
3. Select **ENTER**.

Applying customized user configuration setting

Apply the previously saved user customized picture setting to the projector.

1. Before applying the customized picture setting, adjust the picture setting and save it using **Menu > Image Settings > Picture Settings > User** option.
2. Select **Menu > Image Settings > Apply to User**.
 - User Video
 - User Bright
 - User Enhanced
 - User REC709
 - User DICOM SIM
 - User Blending
 - User HDR
 - User 3D
 - User High Frame Rate
3. To apply the specific picture setting, select the required setting.
4. To confirm the selection, select **ENTER**.

Editing customized picture setting

Edit the previously saved customized picture setting.

1. Select **Menu > Image Settings > User configuration**.
2. Select the customized image setting you want to modify:
 - User-Video
 - User-Bright
 - User-Enhanced
 - User-REC709
 - User-DICOM SIM
 - User-Blending
 - User-HDR
 - User-3D
 - User-High Frame Rate
3. Select **ENTER**.

Setting the contrast ratio

Use contrast enhancement function to raise the contrast ratio.

1. Select **Menu > Image Settings > Contrast Enhancement**.
2. Select the appropriate calculation method for contrast ratio:
 - **Dynamic Black™**—Adjusts the contrast ratio depending on the contents by minimizing the black levels in the projected image while electronically increasing the gain in the image. The result is enhanced detail and increased contrast ratio of 6500:1.
 - **Speed**—Adjusts the speed of the light source correction. The value ranges from 1 to 15. A lower value makes the correction slower and less aggressive while a higher value results in the faster correction.
 - **Strength**—Sets the strength of the dynamic contrast adjustment. The value ranges from 0 to 3, the higher the value the stronger the correction.
 - **Level**—Adjusts the light source when the brightness level of the current content gets lower than the set value. The value ranges from 50 to 100, indicating 50% to 100% of the constant brightness. The higher the value, the larger the range to adjust the light source.
 - **Real Black**—Turns off the laser light while projecting black content.
 - **Lights Out Timer**—Sets a timer for the laser light to turn off after detecting black content.
 - **Lights Out Signal Level**—Sets a black level value as the threshold for the Real Black function. The value can be selected from 0 to 255, with 0 being the darkest black and 255 being the brightest.
 - **Lights On Threshold**—Sets the lights on value to eliminate the Real Black effect. The function is activated when the screen brightness is higher than the value of both the Lights On Threshold and the Lights Out Signal Level. The Lights on Threshold value ranges from 0 to 127.
 - **Reset to Default**—Resets all contract enhancement settings to the default factory defaults.
3. To confirm the selection, select **ENTER**.

Enabling the image freeze

Pause the display screen despite any change in the source device.

1. Select **Menu > Image Settings > Image Freeze**.
2. To pause the screen, select **Image Freeze**.
3. To unfreeze the screen, select any button on the keypad or remote control.
4. Select **Yes**.

Setting the high dynamic range

High dynamic range (HDR) is set to increase the dynamic range which allows the full spectrum of the image to be seen. HDR significantly expands the range of contrast ratio and color to show a more realistic and natural image. After enabling this function, you can see details in the dark, at the same time, the bright part of the image is still visible.



- The HDR function only works when the projector is receiving signal from the HDMI input. You must set Picture Settings to Bright.
- Enabling HDR disables the picture-in-picture/picture-by-picture (PIP/PBP) function.

1. Select **Menu** > **Image Settings** > **HDR**.
2. Select appropriate setting for HDR:
 - **Auto**—Auto detect HDR content.
 - **Level**—Select an appropriate HDR effect.
 - **HDR1**—Low HDR effect, used for bright images to increase the color saturation.
 - **HDR2**—Medium HDR effect, used for standard images to make them look more realistic and natural.
 - **HDR3**—Medium HDR effect, used for video content to improve image details.
 - **HDR4**—Strong HDR effect, used to improve image details in dark scenes.
3. To confirm the selection, select **ENTER**.

Adjust the color of the image

Calibrate the accuracy of primary colors and the wall color, which can change because of lighting and environmental factors. Lighting and other environmental factors may slightly change how these colors appear on your screen. While the change is negligible in most cases, you may prefer to recover the originally intended color performance before trying to match colors from several projectors.

Adjusting primary colors

To achieve consistency use a color meter to measure the native primary colors—red, green, blue, and white, as they appear on the screen. Use hue, saturation and gain (HSG) to adjust each color component to essentially calibrate a projector to its surroundings, compensating for factors such as screen type, lamp and/or ambient lighting, and improves color accuracy and consistency in a group of projectors. It ensures a good starting point for further customizing and matching; however, is not critical for all installations.

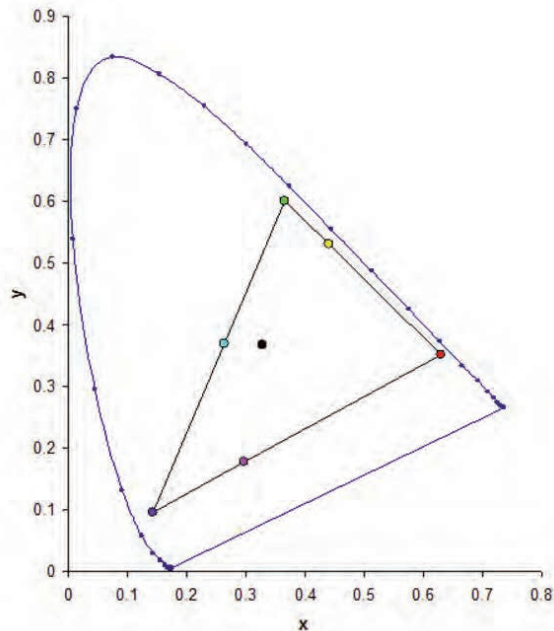

1. Select **Menu > Image Settings > Color Matching > HSG Adjustment**.
2. To view a specific color while adjusting, select **ENTER** to enable **Auto Test Pattern**.
3. Select one primary color (red, green, blue, cyan, magenta, or yellow).
4. To edit hue of the primary color, adjust the slider or enter the color values of the primary color component you selected until satisfied with the colors.
Hue values reflect the number of degrees of rotation around the wheel from the original color of the pixel. Increasing the value indicates counterclockwise rotation and decreasing the value indicates clockwise rotation.
5. To confirm the selection, select **ENTER**.
6. To edit saturation of the primary color, adjust the slider or enter the color values of the primary color component you selected until satisfied with the colors.
Saturation values reflect the color shifting away from the primary color or toward white.
7. To confirm the selection, select **ENTER**.
8. To edit gain of the primary, adjust the slider or enter the color values of the primary color component you selected until satisfied with the colors.
Increasing value indicates increasing the lightness, and decreasing the value indicates decreasing it to black.

9. To confirm your selection, select **ENTER**.
10. Repeat steps 3 to 9 for each primary color component, except white.
11. To edit the color of white by three components—red, blue and green—adjust the slider or enter the values until you are satisfied with the white.
12. To confirm your selection, select **ENTER**.
13. To reset the primary colors to their defaults, select **Reset to Default**.
14. To reset back to default setting, select **ENTER**.

Setting the wall color

Set the wall color so the projector can enhance the color performance customized for the specific wall.

1. Select **Menu > Image Settings > Color Matching > Wall Color**.
2. Select the preferred setting:
 - White
 - Gray 130
 - Light Yellow
3. Select **ENTER**.

Setting the wall color automatically

Set the wall color automatically so the projector can enhance the color performance customized for the specific wall.



- Auto wall color option is disabled and grayed out if the picture mode is set to 3D or High Frame Rate with the current source or change to no source status. (The camera does not support 1x color wheel speed.)
- Auto wall color option is also disabled and grayed out if the camera is not detected.

1. Select **Menu > Image Settings > Color Matching > Auto Wall Color**.
2. Select **ENTER**.

Adjusting the image settings automatically

Adjust various image settings automatically, including focus, wall color, and color uniformity.

Adjusting the image with automatic focus

Adjust the image focus automatically with camera kit.

1. Display an image or test pattern that can be used to analyze image focus.
2. Select **Menu > Image Settings > Auto Image Settings > Auto Focus**.

3. Select **ENTER**.



- Auto focus option is disabled and grayed out if the picture mode is set to 3D or High Frame Rate with the current source or change to no source status. (The camera does not support 1x color wheel speed.)
- Auto focus option is also disabled and grayed out if the camera is not detected or lens lock option is enabled.

Setting the wall color automatically

Set the wall color automatically so the projector can enhance the color performance customized for the specific wall.



- Auto wall color option is disabled and grayed out if the picture mode is set to 3D or High Frame Rate with the current source or change to no source status. (The camera does not support 1x color wheel speed.)
- Auto wall color option is also disabled and grayed out if the camera is not detected.

1. Select **Menu > Image Settings > Auto Image Settings > Auto Wall Color**.
2. Select **ENTER**.

Balancing the image color automatically

Balance the image color automatically with auto color uniformity.



- Image color calibration option is disabled and grayed out if the auto color uniformity option is disabled/unchecked and the picture mode is set to 3D or High Frame Rate with the current source or change to no source status. (The camera does not support 1x color wheel speed.)
- Target selection and reset options are disabled and grayed out if the auto color uniformity option is disabled/unchecked.

1. Select **Menu > Image Settings > Auto Image Settings > Auto Color Uniformity**.
2. Select appropriate option for image color uniformity:
 - **Enable**—Enables or disables the auto color uniformity function.
 - **Calibration**—Starts adjusting the image color.
 - **Target Selection**—Selects a calibration target.
 - **Reset**—Restores factory settings.
3. Select **ENTER**.

Adjusting advanced image settings

Adjust the color value based on gamma, white peaking, color temperature, and save user settings for data recovery.

Adjusting the color value based on gamma setting

Adjust the color values to give a more detailed displayed image.

1. Select **Menu** > **Image Settings** > **Advanced Image Settings** > **Gamma**.
2. Select appropriate option:
 - Video
 - Film
 - Bright
 - CRT
 - DICOM
 - HDR—Only available if the picture mode is set to HDR.
3. Select **ENTER**.

Adjusting the white peaking

Use white peaking to adjust the color of white. The maximum value of white peaking, 100, can increase the brightness of white to near 100%.

1. Select **Menu** > **Image Settings** > **Advanced Image Settings** > **White Peaking**.
2. Adjust the slider by arrow keys or select **ENTER** to input the value.
3. Select **ENTER**.

Adjusting the color temperature

Adjust the color temperature as expressed in degrees Kelvin.

1. Select **Menu** > **Image Settings** > **Advanced Image Settings** > **Color Temperature**.
2. Select appropriate color temperature:
 - **Warmest**—Sets the color temperature to 5500K.
 - **Warm**—Sets the color temperature to 6500K.
 - **Cool**—Sets the color temperature to 7500K.
3. Select **ENTER**.

Saving user settings for data recovery

Create a recovery copy of all the user data. This information can be used later to recover settings if necessary.

1. Select **Menu > Image Settings > Advanced Image Settings > Backup Restore > Save**.
2. To save the user data, select an empty record.
One projector can save up to five backups.
3. To confirm the selection, select **ENTER**.
4. Select **Menu > Image Settings > Advanced Image Settings > Backup Restore > Restore**.
5. To restore a specific backup, select the required record.
6. To start restoring data, select **ENTER**.



- The recovery copy does not include information about the source and functions that can be operated directly from the remote control and do not save the value after the next power on. For example, Image Freeze.
- All other function values are saved to the recovery copy, except for the following:
 - Configuration > Lens Settings
 - Configuration > Communications > LAN/WLAN
 - Size & Position > Geometry Correction
 - Configuration > Menu Preferences > PIN Protect
 - Configuration > Date and Time
 - Configuration > Schedule

Configuring system settings

Learn how to configure the system settings.

Changing the language

Choose the language you want displayed on projector display panel and on-screen display.

1. Select **Menu** > **Configuration** > **Language**.
You can also select **Menu** > **Language**.
2. Select the appropriate language.
3. Select **ENTER**.

Adjusting lens settings

Adjust various lens settings including focus, zoom, lens position, memorizing lens position and locking the lens motors.

Viewing the lens type

View the projector lens type:

- Undefined Lens
- TR 0.65 - 0.75
- TR 0.75 - 1.08
- TR 1.02 - 1.36
- TR 1.08 - 1.5
- TR 1.2 - 1.5
- TR 1.5 - 2.0
- TR 2.0 - 4.0
- TR 4.0 - 7.2
- TR 7.2 - 10.8
- TR 0.38

Aligning the image with focus, zoom, and auto focus

Adjust the image focus automatically with camera kit.

1. Adjust the image focus automatically with camera kit.
2. Select **FOCUS** on keypad or remote control.
You can also select **Menu > Configuration > Lens Settings > Focus**.
3. Use the up and down arrow keys to adjust the focus of the image.
4. To exit the menu, select **EXIT**.
5. To adjust the focus automatically, select **Menu > Configuration > Lens Settings > Auto Focus**.
6. Select **ENTER**.
7. Select **ZOOM** on keypad or remote control.
You can also select **Menu > Configuration > Lens Settings > Zoom**.
8. Use the up and down arrow keys to zoom in or out of the image.
9. To exit the menu, select **EXIT**.
10. To refine your adjusts, repeat steps 2 to 7.

Adjusting the image with automatic focus

Adjust the image focus automatically with camera kit.



- Auto focus option is disabled and grayed out if the picture mode is set to 3D or High Frame Rate with the current source or change to no source status. (The camera does not support 1x color wheel speed).
- Auto focus option is also disabled and grayed out if the camera is not detected or lens lock option is enabled.

1. Display an image or test pattern that can be used to analyze image focus.
2. Select **Menu > Configuration > Lens Settings > Auto Focus**.
3. Select **ENTER**.

Adjusting lens position

Shift the lens to the specific position.

1. Display an image or test pattern that can be used to analyze image location.
2. Select **LENS** on keypad or **LENS H/LENS V** on remote control.
You can also select **Menu > Configuration > Lens Settings > Lens Shift**.
3. Use the arrow keys to adjust the lens position.
4. To exit the menu, select **EXIT**.

Saving lens setting

Save the lens position. One projector can save maximum up to five lens settings.

1. Select **Menu > Configuration > Lens Settings > Lens Shift Memory > Save Current Settings**.
2. To save the lens setting, select an empty record.
3. To confirm the selection, select **ENTER**.

Applying the previous lens setting

Apply the previously saved lens setting to the projector.

1. Before applying the previous lens setting, you need to save the lens setting.
See [Saving lens setting](#) on page 51 for further details.
2. Select **Menu > Configuration > Lens Settings > Lens Shift Memory > Apply Position**.
3. To apply specific lens setting, select the required record.
4. To confirm the selection, select **ENTER**.

Locking the lens motor

Prevent all lens motors from moving. It disables the zoom, focus, and offset settings, locking out any changes and overriding all other lens features. This feature prevents accidental lens position changes in multiple projectors installations.

1. Select **Menu > Configuration > Lens Settings > Lock all Lens Motors**.
2. To enable locking of all lens motors, select **Locked**.
3. To unlock all lens motors, select **Allow**.
4. To confirm the selection, select **ENTER**.

Resetting the lens to home position

Set the lens offset back to the home position.



To make sure the lens shift is functioning properly, Christie recommends calibrating the lens every time the lens are changed.

1. Select **Menu > Configuration > Lens Settings > Lens Calibration**.
You can also select **LENS** on keypad or **LENS H/LENS V** on remote control.
2. Select **ENTER**.
3. To start the lens calibration, select **OK**.

Selecting screen image orientation

Specify the orientation to use for the image. The projector supports front projection, rear projection, front projection inverted, or rear projection inverted.

1. To invert the projection image, select **Menu > Configuration > Ceiling Mount**.
2. Select appropriate ceiling mount settings:
 - **Off**—Disables the ceiling mount setting.
 - **On**—Enables the ceiling mount setting.
 - **Auto**—Detects the orientation automatically.
3. To confirm the image orientation, select **ENTER**.
4. To do a rear projection, select **Menu > Configuration > Rear Projection**.
5. To swap, select **ENTER**.

Adjusting on-screen display menus

Adjust various on-screen display (OSD) settings including the position, OSD transparency and timing for OSD to disappear.

Determining the on-screen display position

Adjust the location of the on-screen display (OSD) menus.

1. Select **MENU > Configuration > Menu Preferences > Menu Horz Offset** or **Menu Vert Offset**.
2. To determine the location on the screen where you want the OSD to appear, adjust the slider by arrow keys or select **ENTER** to input the value.
3. After inputting the value, select **ENTER** to apply.

Showing messages

Enable or disable the on screen message dialogs. For example, input source, IP Address, Slot information, Gamma information, and so on.

1. Select **Menu > Configuration > Menu Preferences > Show Messages**.
2. To swap, select **ENTER**.

Setting the transparency of the on-screen display position

Change the on-screen display (OSD) menus background to be transparent. As the value increases, more of the image behind the menu is visible.



If the projector has not detected an input source, the Menu Transparency function is off.

1. Select **MENU > Configuration > Menu Preferences > Menu Transparency**.
2. Adjust the slider by arrow keys or select **ENTER** to input the value.
3. After inputting the value, select **ENTER** to apply.

Changing the splash screen

Select splash screen which is the screen with no source is displayed.

1. Select **Menu > Configuration > Menu Preferences > Splash Screen Setup**.
2. Select the appropriate splash screen:
 - Factory Logo
 - Blue
 - Black
 - White
3. Select **ENTER**.

Setting time out for on-screen display

Adjust the time for on-screen display to disappear.

1. Select **Menu > Configuration > Menu Preferences > Menu Time Out**.
2. Select the appropriate time:
 - Off
 - 1 Min
 - 3 Min
3. Select **ENTER**.

Setting up password protection

Protect your projector with a password. Once enabled, you must enter the password before you can project an image.

1. Select **Menu > Configuration > Menu Preferences > PIN Protect**.
2. Enter a password by number keys.
3. To confirm the password, select **OK**.

Changing password

Change the current password to a new password.

1. Select **Menu > Configuration > Menu Preferences > Change PIN**.
2. Enter current password by number keys.
3. Select **OK**.
4. Enter new password by number keys.
5. Select **OK**.
6. To confirm the password, enter new password again by number keys.
7. Select **OK**.

Setting up power mode

Adjust various projector's power settings including the shutdown time, sleep timer, and standby mode.

Setting the standby mode

Determine which standby mode the projector is in when AC power on.



Communication mode is the projector's default standby mode. After performing factory reset, manually set the standby mode to 0.5W mode to have less power consumption (<0.5W).

1. Select **Menu > Configuration > Power Management > Standby Mode**.
2. Select the appropriate mode:
 - **0.5W mode**—Less power consumption which does not have the ability to monitor the projector over a network cable in standby mode.
 - **Communication mode**—More power consumption in standby mode which allows you to monitor the projector over a network cable.
3. Select **ENTER**.

Setting the AC power

Enable or disable to power on the projector directly.

1. Select **Menu > Configuration > Power Management > AC Power On**.
2. To toggle, select **ENTER**.

Setting the time for auto shutdown

Set up a time for automatically turns off the projector after no signal is detected for a preset number of minutes. If an active signal is received before the projector powers down, the image is displayed.

1. Select **Menu > Configuration > Power Management > Auto Shutdown**.
2. Select the appropriate time to automatically turn off the projector when there is no signal.
3. To confirm the selection, select **ENTER**.

Setting the sleep timer

Set up a time for automatically power off the projector, after it has been on for a specified amount of time.

1. Select **Menu > Configuration > Power Management > Sleep Timer**.
2. Select the appropriate time to automatically turn off the projector.
3. To confirm the selection, select **ENTER**.

Enabling high altitude setting

Enable high altitude mode when altitudes ≥ 2000 m. The fan operates at high speed to ensure sufficient air flow for high altitudes; however, the noise level of the projector is increased.

1. Select **Menu > Configuration > High Altitude**.
2. To toggle, select **ENTER**.

Setting the projector communication

Enable the receivers and the wired keypad to communicate with the projector from the remote. The front and top IR sensors receive transmissions from the IR remote. Keep the transmission path to these sensors unobstructed for uninterrupted communications with the projector.

1. Select **Menu > Configuration > IR Control**.
2. To enable the top IR sensor, select **Top**.
3. To confirm the selection, select **ENTER**.
4. To enable the front IR sensor, select **Front**.
5. To confirm the selection, select **ENTER**.
6. To enable the signal from the HDBaseT Box, select **HDBaseT**.
7. To confirm the selection, select **ENTER**.

Enabling the 12V Trigger

The 12V trigger is used for electrical projector screens. The projector screen is automatically lowered or raised when the projector is switched on or off.

1. Select **Menu > Configuration > 12V Trigger**.
2. To toggle, select **ENTER**.

Configuring communications

Define and control how single or multiple projectors are linked with each other and with controlling device.

Setting network environment

Determine the communication settings such as network setup, serial port information, and so on.

Adjusting LAN setting

Set up network configuration for wire networking.

1. Select **Menu > Configuration > Communications > LAN**.
2. Set up the appropriate setting:
 - **MAC Address**—Displays the network MAC address value.
 - **Network Status**—Displays the network status
 - **LAN Interface**—Displays the LAN interface. Select either **RJ-45** or **HDBaseT** and select **ENTER** to save.
 - **DHCP**—Enables or disables the DHCP to automatically get IP address, subnet mask, and so on.
 - **IP Address**—Assigns the network IP address.
 - **Subnet Mask**—Assigns the network subnet mask.
 - **Default Gateway**—Assigns the network default gateway.
 - **Primary DNS**—Assigns the primary DNS.
 - **Secondary DNS**—Assigns the secondary DNS.
3. To apply the LAN settings, select **Apply**.

Using the web interface

To control the projector through the web interface, do the following:

1. Start up the web browser on your computer or mobile devices.
2. Enter the IP address set on the projector into the URL of the web browser.
3. Enter the user name and password to login. After a successful login, you can control the projector over the web interface.

Logging on to the web user interface

Log into to the web user interface by following the steps below.

1. Connect the projector to AC and power it on.
2. When the network is available, connect the projector and computer to the same network.
 - a. To check the projector address in a wired network, select **Menu > Configuration > Communications > LAN > IP Address**.
 - b. To check the projector address in a wireless network, select **Menu > Configuration > Communications > WLAN > Default Gateway**.
3. If the network is unavailable, connect the projector to the computer with an RJ45 cable.
 - a. Set the Default Gateway and Subnet Mask of the computer to match the projector.
 - b. Set the IP address of the computer to match the first three numbers of the projector.
For example, if the projector IP address is 192.168.000.100, set the computer IP address to 192.168.000.xxx, where xxx is not 100.
4. Open a web browser and type the projector address in the browser address bar.
5. In the Username field, enter the username.
The default username is admin.
6. In the Password field, enter the password.
The default password is admin.
7. Select **Login**.

Setting the system notification

Configure the Simple Network Management Protocol (SNMP) settings for receiving notifications from the system directly to the email. SNMP provides network administrators with a common way to manage their network devices from a single remote location. Administrators can use the SNMP interface to query a number of devices to see their current status or configuration. Operators can change configuration values and configure trap notifications to be sent when certain events occur (for example, loss of signal, power state change, and so on).

Emails are sent to the mail server configured in the projector settings. Up to two user email accounts can be selected. Important information regarding the event is located in the body content of the email.

SNMP traps are notifications sent from the projector. They are only received by a trap receiver (MIB Browser) in the computer.

1. From the web user interface, select **Network > Notification**.
See *Using the web interface* on page 58 for further information.
2. Set up the appropriate SNMP setting:
 - **SNMP Read Community**—Plain text password that must also be entered in the MIB browser. This password allows various settings in the projector to be queried.
 - **SNMP Location**—Use as a description to where a projector is located in a building. SNMP emails sent specify this location.
 - **Trap IP Address**—Fill in this field with the IP address of the computer, on which you want to view received traps from the projector.
 - **Sender Email**—Set the email account as the source of the system notifications.
 - **SMTP Server**—Enter the IP address of the mail server.
 - **Recipient**—Enter up to two email accounts to receive the system notification.
3. Set the SNMP actions for the system events:
 - **Disabled**—Disable email notification
 - **SNMP Trap**—Send the notification to the trap receiver (MIB Browser).
 - **Email**—Send the notification to the email recipient.
 - **SNMP Trap and Email**—Send the notification to the trap receiver and the email recipient.
4. To apply the notification settings, select **Save**.

Using the RS-232C interface

To control the projector through the RS-232C interface, do the following:

1. Connect your computer and the projector directly using the RS-232 cable.
2. Set the same baud rate in both your computer and projector.
Use commands to control the projector.

Re-connecting the network

After the network is disconnected and timeout using RJ-45/HDBaseT/Wifi, the browser refreshes the page automatically and show HTTP404 (Not Found) error message.

If user wants to re-control the projector, the user must login in the control page with the account and password again.

Adjusting WLAN setting

Set up network configuration for wireless networking.

1. Select **Menu > Configuration > Communications > WLAN**.
2. Set up the appropriate setting:
 - **SSID**—Displays the SSID of the wireless network.
 - **Enable**—Enables or disables the wireless functionality.
 - **Start IP**—Assigns the start IP address of the wireless network.
 - **End IP**—Assigns the end IP address of the wireless network.
 - **Subnet Mask**—Assigns the subnet mask of the wireless.
 - **Default Gateway**—Assigns the gateway of the wireless.
3. To apply the WLAN settings, select **Apply**.

Adjusting network setting

Set up network configuration setting, such as reset back to default.

1. Select **Menu > Configuration > Communications > Network**.
2. Set up the appropriate network setting:
 - **Show Network Message**—Enables or disables to display of the network message.
 - **Reset to Default**—Resets the network configuration setting, including LAN setting and WLAN setting, to default.
3. To apply the network configuration, select **ENTER**.

Setting serial port baud rate

Select the serial port and baud rate.

1. Select **Menu > Configuration > Communications > Serial Port Baud rate**.
2. Set up the appropriate baud rate.
3. To confirm the selection, select **ENTER**.

Enabling serial port echo

Enable or disable to allow the CLI pass through.

1. Select **Menu > Configuration > Communications > Serial Port Echo**.
2. To swap, select **ENTER**.

Setting the projector address

Assign an address to the projector for IR remote connection.

1. To set the projector address, select **Menu > Configuration > Communications > Projector Address**.
2. Select specific number for this projector from 0 to 9.
3. To match up with the projector address, select **PROJ** and specific number key.
The projector responds to the IR remote set to the same address as the projector or to the IR remote set to address 0.

Adjusting the back light settings

Control the back light behavior and timeout setting for the keypad and status LED.

1. Select **Menu > Configuration > Backlight Preferences > Keypad Backlight**.
2. Select the appropriate setting for keypad backlight.
3. To confirm the selection, select **ENTER**.
4. Select **Menu > Configuration > Backlight Preferences > Status LED**.
5. Select the appropriate setting for status LED.
6. To confirm the selection, select **ENTER**.

Setting the hot key

To directly call out a function without going through the layers of the on-screen display (OSD) menus, select a specific function for a hot key. To access this function, select **HOT KEY** on the remote control.



When the hot key is set to Disable Warp/Blend, selecting the hot key once disables the currently applied warp and blend. Selecting the hot key again enables the function and returns the warp and blend to the screen.

1. Select **Menu > Configuration > Hot-Key Settings**.
2. Select the one function for the hot key:
 - Size Presets
 - Picture Settings
 - Default Value
 - Detail
 - Contrast Enhancement
 - Light Source Mode
 - Image Freeze
 - Information
 - Disable Warp/Blend

3. To set the selected function as the hot key, select **ENTER**.

Configuring date and time settings

Configure the date and time settings of the projector. Make sure these settings are accurate if you want to use the schedule feature.

1. Select **Menu > Configuration > Date and Time**.
2. Set up the appropriate setting:
 - **Clock Mode**—Sets the clock mode to Local or Network. A NTP Server is required if the clock mode is set to Network.
 - **Date**—Sets a date for the projector. The date format is Year/Month/Date.
 - **Time**—Sets the time for the projector.
 - **Daylight Saving Time**—Configures the daylight saving settings if required.
 - **NTP Server**—Selects a NTP Server for the network clock mode.
 - **Time Zone**—Selects an appropriate time zone for the network clock mode.
 - **Update Interval**—Sets the date and time update interval.
3. To apply the date and time settings, select **Apply**.

Scheduling events

Schedule feature allows you to schedule various projector functions at the given date and time.

1. Select **Menu > Configuration > Schedule**.
2. View or set up the appropriate setting:
 - **Date and Time**—Adjusts the date and time for the projector.
 - **Schedule Mode**—Enables the schedule mode if you want to schedule projector functions.
 - **View Today**—Displays events scheduled for the current day.
 - **Monday to Sunday**—Sets up schedule for days of a week.
 - **Event 01-016**—See step 5 in [Setting up a schedule](#) on page 63 for a full list of available actions.
 - **Copy Events To**—If several days of a week have the same schedule, create a fully scheduled day, select **Copy Events To**, and select these days of the week where you want to copy the full schedule.
 - **Reset Schedule**—Resets all of the schedule settings to the factory defaults.

Setting up a schedule

1. Select **Menu** > **Configuration** > **Schedule**.
2. Select the appropriate day of the week when you want to schedule events and select **ENTER**.
The schedule table for the selected day is shown.
3. Select the first event slot and select **ENTER**.
The event submenu is shown.
4. Select the **Time** when the chosen event must occur, for example at 11 AM.
5. Select the appropriate action to take place:
 - Power Settings
 - Off/On
 - Power On
 - 0.5W Mode
 - Communication Mode
 - Input Source
 - Off
 - HDMI1
 - HDMI2
 - Display Port
 - 12G-SDI
 - HDBaseT
 - Light Source Mode
 - Off
 - Constant Power
 - Constant Intensity
 - ECO 1
 - ECO 2
 - Shutter
 - Off
 - Shutter On
 - Shutter Off
6. To confirm the selection, select **ENTER**.
7. Select **EXIT** and return to the schedule table of the selected day.

8. Repeat steps 2 to 7 to schedule more events for the selected day.
You can schedule up to 16 events per day. To access the events on the next page, select the arrow keys.
9. To schedule events for other days, select **EXIT** to return to the main Schedule menu and repeat steps 2 to 8.

Configuring light settings

Learn how to configure the light settings.

Setting light source mode

Set up light source mode depending the environment.

1. Select **Menu > Light Source > Light Source Mode**.
2. Select appropriate light source mode:
 - **Constant Power**—Enable Constant Power to set the projector brightness to a specific level controlled by the laser diode power. See [Adjusting the light power](#) on page 66 for further details of setting the laser diode power.
If constant power is enabled in the projector then this function is activated when the voltage is below 140 Vac. For example, if constant power in 4K22-HS is set to 77 then the projector will keep the laser diode power at 85% which is around ~1300W.
 - **Constant Intensity**—After enabling Constant Power, select Constant Intensity to maintain current constant brightness and color settings. This function can remain at current setting for longer period of time than Constant Power mode and is used for long-term projecting or blending.
Perform light sensor calibration before enabling Constant Intensity.
When Constant Intensity is enabled, Dynamic Black and Real Black functions are automatically disabled.
When Picture Settings is changed under Constant Intensity, the light source mode automatically changes back to Constant Power..
 - **ECO 1 (80%)**—Set the projector to 80% constant brightness and color settings.
 - **ECO 2 (50%)**—Set the projector to 50% constant brightness and color settings.
3. Select **ENTER**.

Adjusting the light power

Set the value of the laser diode power. The power levels can be managed to obtain the brightest picture or longest light source life. The minimum setting of the light power is 30% brightness and color setting, and the maximum is 100% brightness and color setting.

1. Select **Menu > Light Source > Constant Power**.
2. Adjust the slider by arrow keys or select **ENTER** to input the value you selected.
3. After inputting the value, select **ENTER** to apply.

Diagnostic tools

Follow these procedures to help diagnose issues with HS Series 4K projectors.

Viewing projector information

View the status of the projector, source information, light source information, and communication information. The information is read-only.

1. To view the status of the projector, such as model name, serial number, and so on, select **Menu > Information > Status Info**.
2. To view source information, such as active source, signal format, and so on, select **Menu > Information > Source Info**.
3. To view backup input information, such as backup input status, backup input change, and so on, select **Menu > Information > Backup Input Info**.
4. To view the communication information, such as network status, projector's IP address, subnet, and so on, select **Menu > Information > Communications Info**.
5. To view the light source information, such as total projector hours and laser diode (LD) hours, select **Menu > Information > Light Source Info**.
6. To view the firmware information, such as firmware (FW) version, and so on, select **Menu > Information > Firmware Version Info**.

Selecting a test pattern

Use the projector's test patterns to assist with configuration of the projector and to diagnose any issues that may occur.

1. Select Test Pattern on remote control.
You can also select the test patterns from **Menu > Test Pattern**.
2. Scroll through the list of test patterns by left and right arrow keys on remote control.
3. Select the required test pattern.
4. To confirm your selection, select **ENTER**.

Restoring factory default settings

Restoring factory settings removes all custom device settings.



To avoid warranty violation, only Christie-qualified technicians can reset factory defaults.

1. Select **MENU > Configuration > Service**.
2. Enter the service password.
3. Select **Factory Reset**.

All customized settings are set to the default factory settings.

4. At the confirmation prompt, select **OK**.

Configuring input settings

Learn how to configure the input source and picture in picture (PIP)/picture by picture (PBP) settings.

Setting main input source

Set up the active input to be used as the main image.

1. Select **Menu > Input Switching & PIP > Main Input**.
2. To select the active input, select **ENTER**.

Setting second input source

Select an active input to be used as the picture in picture (PIP)/picture by picture (PBP). Before setting the second input source, make sure to enable PIP/PBP otherwise this item is disabled.

1. Select **Menu > Input Switching & PIP > PIP/PBP Input**.
2. To select another active input, select **ENTER**.

Enabling second input source

To activate the picture in picture (PIP)/picture by picture (PBP) setting, switch on this function.



To update the PIP/PBP mode, run the **Input Switching & PIP > Auto Image Resync** function. Auto Image Resync synchronizes the main input and the sub input sources simultaneously.

1. Select **Menu > Input Switching & PIP > PIP/PBP Enable**.
2. To swap, select **ENTER**.

Swapping main input and second input source

Switch the main input source with second input source. Before this action, make sure to enable picture-in-picture/picture-by-picture.

1. Select **Menu > Input Switching & PIP > Swap**.
2. To swap, select **ENTER**.

Setting the size of second input source

Set the size of picture-in-picture (PIP)/picture-by-picture (PBP). Before this action, make sure to enable PIP/PBP. See *Input sources layout and size* on page 70 for further details of the layout and size.

1. Select **Menu > Input Switching & PIP > Size**.
2. Select the appropriate size, small, medium or large, for PIP/PBP input source.
3. To confirm the selection, select **ENTER**.







Setting up the display layout with two input sources



















Set the display location for main input source and second input source on the screen. Before this action, make sure to enable PIP/PBP. See *Input sources layout and size* on page 70 for further details of the layout and size.

1. Select **Menu > Input Switching & PIP > Layout**.
2. Select the appropriate layout.
3. To confirm the selection, select **ENTER**.

Input sources layout and size

A P indicates the primary source region (lighter color) and an asterisk (*) indicates both regions are the same size.

PIP/PBP layout	PIP/PBP size		
	Small	Medium	Large
PBP, Main Left			 *
PBP, Main Top			 *

PIP/PBP layout	PIP/PBP size		
	Small	Medium	Large
PBP, Main Right			 *
PBP, Main Bottom			 *
PIP, Sub Bottom Right			
PIP, Sub Bottom Left			
PIP, Sub Top Left			
PIP, Sub Top Right			

Setting the timing detection mode

Set timing detection mode to enhanced or normal to support additional PC timings. When the projected picture is not completed, this function is used to adjust the picture.

1. Select **Menu > Input Switching & PIP > Auto Image Resync**.
2. Select the appropriate mode:
 - **Normal**—If the input signal source has been plugged to the same port on the projector and not been unplugged, the projector can process the signal at a faster speed.
 - **Enhanced**—Every time the projector receives the signal, it analyzes the source signal and verifies the integrity of it. This ensures the optimal image quality but consumes more time.
3. To confirm the selection, select **ENTER**.

Setting the input searching method

Set the most suited method for searching input source.

1. Select **Menu > Input Switching & PIP > Input key**.
2. Select the appropriate searching method:
 - **Change Sources**—Changes the source manually by selecting **INPUT** on the keypad or remote control.

- **List all Sources**—Selects listing all the input sources available for selection.
 - **Auto Sources**—Automatically searches the source.
3. To confirm the selection, select **ENTER**.

Setting up the backup input

Use the Backup Input function to set up two input sources with the same timing specification using the HDMI switch/splitter. Upon loss of one input source due to the damaged cable, the projector automatically switches to the other source. The switching time is less than 1 second.



- The supported sources are HDMI 1, HDMI 2, Display Port, and HDBaseT.
 - PIP/PBP, Auto Source, 3D, and 120Hz timing conditions are not supported.
 - The primary and secondary source must have the same Resolution, Horz Refresh/Frame Rate, and Color Space settings.
1. Select **Menu > Input Switching & PIP > Backup Input**.
 2. Set up the appropriate setting:
 - **Auto Switch**—Selects the checkbox to enable automatically switch to backup input source when the current signal fails.
 - **Current Signal**—Shows the current active signal.
 - **First Input**—Selects the first input. When the selected source is activated, the on-screen display (OSD) menu displays the signal's Resolution, Horz Refresh, and Color Space.
 - **Second Input**—Selects the second input. When the selected source is activated, the OSD menu displays the signal's Resolution, Horz Refresh, and Color Space.

Adjusting the sub image

Adjust the image related settings for the sub source in PIP mode.

1. Select **Menu > Input Switching & PIP > Adjust Sub Image**.
2. Select the appropriate color space for the sub source:

Enabling low latency mode

Enable the Low Latency Mode to minimize the input lag. This function is used for live broadcasting, streaming media, and similar installations.

1. Select **Menu > Input Switching & PIP > Low Latency Mode**.
2. Select the appropriate mode.
 - **Normal**—No functional restrictions but longer delay time.
 - **Ultra**—Reduces latency in 2D mode but sets restrictions when warping the image. Ultra does not support 3D, input timings outside the range of 60fps, 120fps and 240fps, PIP/PBP mode, and image freeze.
3. To confirm the selection, select **ENTER**.

Configuring the EDID setting

Enable or disable the Extended Display Identification Data (EDID) for HDMI 2.0 to play videos from hardware devices, such as DVD players.

The most commonly used HDMI versions are HDMI 1.4 and 2.0, with differences in bandwidth. HDMI 1.4 has limited rate of 2K. 4K22-HS and 4K13-HS projectors are compatible with both HDMI 1.4 and HDMI 2.0.

When the projector is connected to a hardware device supporting HDMI 1.4 only, disable the EDID for HDMI 2.0 to play the videos properly.

1. Select **Menu > Input Switching & PIP > EDID**.
2. Select the **HDMI 1**, **HDMI 2**, or **HDBaseT** item where you want to enable EDID.
3. Set **1.4** or **2.0**.
4. To confirm the setting, select **ENTER**.

Configuring the HDMI output

Set the default HDMI output port.



If multiple projectors are connected to each other in a daisy chain, the HDR signal output is determined by the first projector and PC handshake.

1. Select **Menu > Input Switching & PIP > HDMI Out put**.
2. Select **HDMI 1** or **HDMI 2** as the HDMI output.
3. To confirm the setting, select **ENTER**.

Signal connectivity specifications

Identify the signal connectivity specifications for HS Series 4K projectors.

The list of formats listed below are not exhaustive and other formats may be supported. For more information, contact Christie Technical Support.

HDMI1/HDMI2 video formats

Identify the video formats for the HDMI1/HDMI2 input.

Signal type	Signal format	Resolution	Aspect ratio		V sync (Hz)	RGB			YCbCr 4:4:4			YCbCr 4:2:2	
						8 bit	10 bit	12 bit	8 bit	10 bit	12 bit	8 bit	
PC	XGA	1024 x 768	1.33	4:3	60	V	V	V	V	V	V	V	
					70	V	V	V	V	V	V	V	
	XGA	1024 x 768	1.33	4:3	75	V	V	V	V	V	V	V	
					85	V	V	V	V	V	V	V	
					120	V	V	V	V	V	V	V	
	SXGA	1152 x 864	1.33	4:3	75	V	V	V	V	V	V	V	
		1152 x 870			1.32	75	V	V	V	V	V	V	V
	WXGA	1280 x 768	1.67	5:3	60	V	V	V	V	V	V	V	
					75	V	V	V	V	V	V	V	
					85	V	V	V	V	V	V	V	
	WXGA	1280 x 800	1.6	16:10	60	V	V	V	V	V	V	V	
					75	V	V	V	V	V	V	V	
					85	V	V	V	V	V	V	V	
	SXGA	1280 x 960	1.33	4:3	60	V	V	V	V	V	V	V	
					85	V	V	V	V	V	V	V	
		1280 x 1024	1.25	5:4	60	V	V	V	V	V	V	V	
					75	V	V	V	V	V	V	V	
	WXGA	1360 x 768	1.78	16:9	60	V	V	V	V	V	V	V	
		1366 x 768				V	V	V	V	V	V	X	
	SXGA+	1400 x 1050	1.33	4:3		V	V	V	V	V	V	V	
	WXGA+	1440 x 900	1.6	16:10	60	V	V	V	V	V	V	V	V
					75	V	V	V	V	V	V	V	
					85	V	V	V	V	V	V	V	
	WXGA++	1600 x 900	1.78	16:9	60	V	V	V	V	V	V	V	
UXGA	1600 x 1200	1.33	4:3	50	V	V	V	V	V	V	V		
				60	V	V	V	V	V	V	V		
WSXGA+	1680 x 1050	1.6	16:10		V	V	V	V	V	V	V		
WUXGA RB	1920 x 1200RB			50	V	V	V	V	V	V	V		
		60	V	V	V	V	V	V	V				

Signal type	Signal format	Resolution	Aspect ratio		V sync (Hz)	RGB			YCbCr 4:4:4			YCbCr 4:2:2
						8 bit	10 bit	12 bit	8 bit	10 bit	12 bit	8 bit
TV	HDTV (1080i)	1920 x 1080	1.78	16:9	50	V	V	V	V	V	V	V
					59.94	V	V	V	V	V	V	V
					60	V	V	V	V	V	V	V
					50	V	V	V	V	V	V	V
					59.94	V	V	V	V	V	V	V
					60	V	V	V	V	V	V	V
	HDTV (720p)	1280 x 720	1.78	16:9	120	V	V	V	V	V	V	V
					23.98	V	V	V	V	V	V	V
					24	V	V	V	V	V	V	V
					25	V	V	V	V	V	V	V
					29.97	V	V	V	V	V	V	V
					30	V	V	V	V	V	V	V
	HDTV (1080p)	1920 x 1080	1.78	16:9	50	V	V	V	V	V	V	V
					59.94	V	V	V	V	V	V	V
					60	V	V	V	V	V	V	V
					120	V	V	V	V	V	V	V
					23.98	V	V	V	V	V	V	V
					24	V	V	V	V	V	V	V
Mandatory 3D	Frame Packing (1080p)	1920 x 1080	1.78	16:9	24	V	V	V	V	V	V	V
					50	V	V	V	V	V	V	V
					59.94	V	V	V	V	V	V	V
					60	V	V	V	V	V	V	V
					50	V	V	V	V	V	V	V
					59.94	V	V	V	V	V	V	V
	Frame Packing (720p)	1280 x 720	1.78	16:9	60	V	V	V	V	V	V	V
					50	V	V	V	V	V	V	V
					59.94	V	V	V	V	V	V	V
					60	V	V	V	V	V	V	V
					50	V	V	V	V	V	V	V
					59.9	V	V	V	V	V	V	V
	Side by Side (1080i)	1920 x 1080	1.78	16:9	60	V	V	V	V	V	V	V
					50	V	V	V	V	V	V	V
					59.94	V	V	V	V	V	V	V
					60	V	V	V	V	V	V	V
					24	V	V	V	V	V	V	V
					50	V	V	V	V	V	V	V
Side by Side (1080p)	1920 x 1080	1.78	16:9	59.9	V	V	V	V	V	V	V	
				60	V	V	V	V	V	V	V	
				50	V	V	V	V	V	V	V	
				59.94	V	V	V	V	V	V	V	
				60	V	V	V	V	V	V	V	
				24	V	V	V	V	V	V	V	
Top and Bottom (720p)	1280 x 720	1.78	16:9	50	V	V	V	V	V	V	V	
				59.94	V	V	V	V	V	V	V	
				60	V	V	V	V	V	V	V	
				23.98	V	V	V	V	V	V	V	
				24	V	V	V	V	V	V	V	
				59.9	V	V	V	V	V	V	V	
Top and Bottom (1080p)	1920 x 1080	1.78	16:9	60	V	V	V	V	V	V	V	
				23.98	V	V	V	V	V	V	V	
				24	V	V	V	V	V	V	V	
				59.9	V	V	V	V	V	V	V	
				60	V	V	V	V	V	V	V	
				24	V	V	V	V	V	V	V	

Signal type	Signal format	Resolution	Aspect ratio		V sync (Hz)	RGB			YCbCr 4:4:4			YCbCr 4:2:2	
						8 bit	10 bit	12 bit	8 bit	10 bit	12 bit	8 bit	
Frame Sequential 3D	XGA	1024 x 768	1.33	4:3	120	V	V	V	V	V	V	V	
	HDTV	1280 x 720	1.78	16:9		V	V	V	V	V	V	V	
	1080p	1920 x 1080				V	V	V	V	V	V	V	
	WUXGA	1920 x 1200	1.6	16:10	60	V	V	V	V	V	V	V	
					V	V	V	V	V	V	V		
4K	3840 x 2160	3840 x 2160	1.78	16:9	24	V	V	V	V	V	V	V	
					25	V	V	V	V	V	V	V	
					30	V	V	V	V	V	V	V	
					50	V	X	X	V	X	X	V	
					60	V	X	X	V	X	X	V	
	4096x2160 SMPTE	4096 x 2160	1.90			24	V	V	V	V	V	V	V
						25	V	V	V	V	V	V	V
						30	V	V	V	V	V	V	V
						50	V	X	X	V	X	X	V
						60	V	X	X	V	X	X	V
Dual Pipe	1080p	1920x1080	1.78	16:9	60	V	V	V	V	V	V		
4K 3D (Passive 3D)	3840x2160	3840x2160			V	X	X	V	X	X	V		
					60	V	X	X	V	X	X	V	
4K 3D Dual Pipe (Passive 3D)													
High Frame Rate	1080p	1920x1080			240	V	X	X	V	X	X	V	

(V): Video format is supported.

(X): Video format is not supported.

Display Port video formats

Identify the video formats for the Display Port input.

Signal type	Signal format	Resolution	Aspect ratio		V sync (Hz)	RGB			YCbCr 4:4:4			YCbCr 4:2:2
						8 bit	10 bit	12 bit	8 bit	10 bit	12 bit	8 bit
PC	XGA	1024 x 768	1.33	4:3	60	V	V	V	V	V	V	V
					70	V	V	V	V	V	V	V
					75	V	V	V	V	V	V	V
					85	V	V	V	V	V	V	V
					120	V	V	V	V	V	V	V
	SXGA	1152 x 864	1.32	5:3	75	V	V	V	V	V	V	V
		1152 x 870			75	V	V	V	V	V	V	V
	WXGA	1280 x 768	1.67	5:3	60	V	V	V	V	V	V	V
					75	V	V	V	V	V	V	V
					85	V	V	V	V	V	V	V
		1280 x 800	1.6	16:10	60	V	V	V	V	V	V	V
					75	V	V	V	V	V	V	V
85					V	V	V	V	V	V	V	
TV	SXGA	1280 x 960	1.33	4:3	60	V	V	V	V	V	V	V
					85	V	V	V	V	V	V	V
		1280 x 1024	1.25	5:4	60	V	V	V	V	V	V	V
					75	V	V	V	V	V	V	V
	85				V	V	V	V	V	V	V	
	60				V	V	V	V	V	V	V	
	WXGA	1360 x 768	1.78	16:9	60	V	V	V	V	V	V	V
		1366 x 768			V	V	V	V	V	V	V	
	SXGA+	1400 x 1050	1.33	4:3		V	V	V	V	V	V	V
	WXGA+	1440 x 900	1.6	16:10	60	V	V	V	V	V	V	V
					75	V	V	V	V	V	V	V
					85	V	V	V	V	V	V	V
	WXGA++	1600 x 900	1.78	16:9	60	V	V	V	V	V	V	V
	UXGA	1600 x 1200	1.33	4:3	50	V	V	V	V	V	V	V
					60	V	V	V	V	V	V	V
						V	V	V	V	V	V	V
	WSXGA+	1680 x 1050	1.6	16:10		V	V	V	V	V	V	V
	WUXGA RB	1920 x 1200RB			50	V	V	V	V	V	V	V
				60	V	V	V	V	V	V	V	

Signal type	Signal format	Resolution	Aspect ratio	V sync (Hz)	RGB			YCbCr 4:4:4			YCbCr 4:2:2		
					8 bit	10 bit	12 bit	8 bit	10 bit	12 bit	8 bit		
TV	HDTV (1080i)	1920 x 1080	1.78	16:9	50	V	V	V	V	V	V	V	
					59.94	V	V	V	V	V	V	V	
					60	V	V	V	V	V	V	V	
	HDTV (720p)	1280 x 720	1.78	16:9	50	V	V	V	V	V	V	V	
					59.94	V	V	V	V	V	V	V	
					60	V	V	V	V	V	V	V	
	HDTV (1080p)	1920 x 1080	1.78	16:9	120	X	X	X	X	X	X	X	
					23.98	V	V	V	V	V	V	V	
					24	V	V	V	V	V	V	V	
					25	V	V	V	V	V	V	V	
					29.97	V	V	V	V	V	V	V	
					30	V	V	V	V	V	V	V	
					50	V	V	V	V	V	V	V	
					59.94	V	V	V	V	V	V	V	
					60	V	V	V	V	V	V	V	
	Mandatory 3D	Frame Packing (1080p)	1920 x 1080	1.78	16:9	120	V	V	V	V	V	V	V
						23.98	X	X	X	X	X	X	X
						24	X	X	X	X	X	X	X
Frame Packing (720p)		1280 x 720	1.78	16:9	50	X	X	X	X	X	X	X	
					59.94	X	X	X	X	X	X	X	
					60	X	X	X	X	X	X	X	
Side by Side (1080i)		1920 x 1080	1.78	16:9	50	X	X	X	X	X	X	X	
					59.94	X	X	X	X	X	X	X	
					60	X	X	X	X	X	X	X	
Side by Side (1080p)		1920 x 1080	1.78	16:9	24	X	X	X	X	X	X	X	
					50	X	X	X	X	X	X	X	
					59.9	X	X	X	X	X	X	X	
Top and Bottom (720p)		1280 x 720	1.78	16:9	60	X	X	X	X	X	X	X	
					50	X	X	X	X	X	X	X	
					59.94	X	X	X	X	X	X	X	
						60	X	X	X	X	X	X	

Signal type	Signal format	Resolution	Aspect ratio		V sync (Hz)	RGB			YCbCr 4:4:4			YCbCr 4:2:2
						8 bit	10 bit	12 bit	8 bit	10 bit	12 bit	8 bit
Mandatory 3D	Top and Bottom (1080p)	1920 x 1080	1.78	16:9	23.98	X	X	X	X	X	X	X
					24	X	X	X	X	X	X	X
					59.9	X	X	X	X	X	X	X
					60	X	X	X	X	X	X	X
Frame Sequential 3D	XGA	1024 x 768	1.33	4:3	120	V	V	V	V	V	V	V
	HDTV	1280 x 720	1.78	16:9	60	V	V	V	V	V	V	V
	1080p	1920 x 1080				V	V	V	V	V	V	
	WUXGA	1920 x 1200	1.6	16:10		V	V	V	V	V	V	V
4K	3840 x 2160	3840 x 2160	1.78	16:9	24	V	X	X	V	X	X	V
					25	V	X	X	V	X	X	V
					30	V	X	X	V	X	X	V
					50	V	X	X	V	X	X	V
					60	V	X	X	V	X	X	V
	4096x2160 SMPTE	4096 x 2160	1.90	24	V	X	X	V	X	X	V	
				25	V	X	X	V	X	X	V	
				30	V	X	X	V	X	X	V	
				50	V	X	X	V	X	X	V	
				60	V	X	X	V	X	X	V	
4K 3D (Passive 3D)	3840x2160	3840x2160	1.78	16:9	60	V	X	X	V	X	X	V
4K 3D Dual Pipe (Passive 3D)						V	X	X	V	X	X	V
High Frame Rate	1080p	1920x1080			240	V	X	X	V	X	X	V

(V): Video format is supported.

(X): Video format is not supported.

12G-SDI video formats

Identify the video formats for the 12G-SDI input.

Signal type	Signal format	Resolution	Aspect ratio		V sync (Hz)	YCbCr 4:2:2 10 bit
SD-SDI	SDTV (480i)	720 x 480	1.5	3:2	59.94	V
	SDTV (576i)	720 x 576	1.25	5:4	50	V
HD-SDI	HDTV (720p)	1280 x 720	1.78	16:9	50	V
					59.94	V
					60	V
	HDTV (1080i)	1920 x 1080			50	V
					59.94	V
					60	V
	HDTV (1080p)	1920 x 1080			23.98	V
					24	V
					25	V
					29.97	V
					30	V
					50	V
3GA-SDI	HDTV (1080p)	1920 x 1080	59.94	V		
			60	V		
			24	V		
12G-SDI (SMPTE ST-2082-10)	3840x2160p	3840x2160	25	V		
			30	V		
			50	V		
			60	V		
			24	V		

(V): Video format is supported.

(X): Video format is not supported.

HDBaseT video formats

Identify the video formats for the HDBaseT input.

Signal type	Signal format	Resolution	Aspect ratio		V Sync (Hz)	RGB			YCbCr 4:4:4			YCbCr 4:2:2	
						8 bit	10 bit	12 bit	8 bit	10 bit	12 bit	8 bit	
PC	XGA	1024 x 768	1.33	4:3	60	V	V	V	V	V	V	V	V
					70	V	V	V	V	V	V	V	V
					75	V	V	V	V	V	V	V	V
					85	V	V	V	V	V	V	V	V
					120	V	V	V	V	V	V	V	V
	SXGA	1152 x 864	1.32	5:3	75	V	V	V	V	V	V	V	V
		1152 x 870			75	V	V	V	V	V	V	V	V
	WXGA	1280 x 768	1.67	5:3	60	V	V	V	V	V	V	V	V
					75	V	V	V	V	V	V	V	V
					85	V	V	V	V	V	V	V	V
		1280 x 800	1.6	16:10	60	V	V	V	V	V	V	V	V
					75	V	V	V	V	V	V	V	V
85	V	V	V	V	V	V	V	V	V				
TV	SXGA	1280 x 960	1.33	4:3	60	V	V	V	V	V	V	V	V
					85	V	V	V	V	V	V	V	V
		1280 x 1024	1.25	5:4	60	V	V	V	V	V	V	V	V
					75	V	V	V	V	V	V	V	V
	85	V	V	V	V	V	X	V	V				
	WXGA	1360 x 768	1.78	16:9	60	V	V	V	V	V	V	V	V
		1366 x 768				V	V	V	V	V	V	V	V
	SXGA+	1400 x 1050	1.33	4:3		V	V	V	V	V	V	V	
	WXGA+	1440 x 900	1.6	16:10	60	V	V	V	V	V	V	V	V
					75	V	V	V	V	V	V	V	V
					85	V	V	V	V	V	V	V	V
	WXGA++	1600 x 900	1.78	16:9	60	V	V	V	V	V	V	V	
	UXGA	1600 x 1200	1.33	4:3	50	V	V	V	V	V	V	V	V
					60	V	V	V	V	V	X	V	V
	WSXGA+	1680 x 1050	1.6	16:10		V	V	V	V	V	V	V	V
	WUXGA RB	1920 x 1200RB			50	V	V	V	V	V	V	V	V
			60	V	V	V	V	V	X	V	V		

Signal type	Signal format	Resolution	Aspect ratio		V Sync (Hz)	RGB			YCbCr 4:4:4			YCbCr 4:2:2	
						8 bit	10 bit	12 bit	8 bit	10 bit	12 bit	8 bit	
TV	HDTV (1080i)	1920 x 1080	1.78	16:9	50	V	V	V	V	V	V	V	V
					59.94	V	V	V	V	V	V	V	V
					60	V	V	V	V	V	V	V	V
					50	V	V	V	V	V	V	V	V
					59.94	V	V	V	V	V	V	V	V
					60	V	V	V	V	V	V	V	V
	HDTV (720p)	1280 x 720	1.78	16:9	120	V	V	V	V	V	V	V	V
					23.98	V	V	V	V	V	V	V	V
					24	V	V	V	V	V	V	V	V
					25	V	V	V	V	V	V	V	V
					29.97	V	V	V	V	V	V	V	V
					30	V	V	V	V	V	V	V	V
	HDTV (1080p)	1920 x 1080	1.78	16:9	50	V	V	V	V	V	V	V	V
					59.94	V	V	V	V	V	V	V	V
					60	V	V	V	V	V	V	V	V
					120	V	V	V	V	V	V	V	V
					23.98	V	V	V	V	V	V	V	V
					24	V	V	V	V	V	V	V	V
Mandatory 3D	Frame Packing (1080p)	1920 x 1080	1.78	16:9	24	V	V	V	V	V	V	V	V
					50	V	V	V	V	V	V	V	V
					59.94	V	V	V	V	V	V	V	V
					60	V	V	V	V	V	V	V	V
					50	V	V	V	V	V	V	V	V
					59.94	V	V	V	V	V	V	V	V
	Frame Packing (720p)	1280 x 720	1.78	16:9	60	V	V	V	V	V	V	V	V
					50	V	V	V	V	V	V	V	V
					59.94	V	V	V	V	V	V	V	V
					60	V	V	V	V	V	V	V	V
					50	V	V	V	V	V	V	V	V
					59.94	V	V	V	V	V	V	V	V
	Side by Side (1080i)	1920 x 1080	1.78	16:9	60	V	V	V	V	V	V	V	V
					24	V	V	V	V	V	V	V	V
					50	V	V	V	V	V	V	V	V
					59.9	V	V	V	V	V	V	V	V
					60	V	V	V	V	V	V	V	V
					50	V	V	V	V	V	V	V	V
Side by Side (1080p)	1920 x 1080	1.78	16:9	59.94	V	V	V	V	V	V	V	V	
				60	V	V	V	V	V	V	V	V	
				50	V	V	V	V	V	V	V	V	
				59.9	V	V	V	V	V	V	V	V	
				60	V	V	V	V	V	V	V	V	
				50	V	V	V	V	V	V	V	V	
Top and Bottom (720p)	1280 x 720	1.78	16:9	59.94	V	V	V	V	V	V	V	V	
				60	V	V	V	V	V	V	V	V	
				50	V	V	V	V	V	V	V	V	
				59.94	V	V	V	V	V	V	V	V	
				60	V	V	V	V	V	V	V	V	
				50	V	V	V	V	V	V	V	V	
Top and Bottom (1080p)	1920 x 1080	1.78	16:9	23.98	V	V	V	V	V	V	V	V	
				24	V	V	V	V	V	V	V	V	
				59.9	V	V	V	V	V	V	V	V	
				60	V	V	V	V	V	V	V	V	
				50	V	V	V	V	V	V	V	V	
				59.94	V	V	V	V	V	V	V	V	

Signal type	Signal format	Resolution	Aspect ratio		V Sync (Hz)	RGB			YCbCr 4:4:4			YCbCr 4:2:2	
						8 bit	10 bit	12 bit	8 bit	10 bit	12 bit	8 bit	
Frame Sequential 3D	XGA	1024 x 768	1.33	4:3	120	V	V	V	V	V	V	V	
	HDTV	1280 x 720	1.78	16:9		V	V	V	V	V	V	V	
	1080p	1920 x 1080				V	V	V	V	V	V	V	
	WUXGA	1920 x 1200	1.6	16:10	60	V	V	V	V	V	V	V	
					V	V	V	V	V	V	V		
4K	3840 x 2160	3840 x 2160	1.78	16:9	24	V	V	V	V	V	V	V	
					25	V	V	V	V	V	V	V	
					30	V	V	V	V	V	V	V	
					50	V	X	X	V	X	X	V	
					60	V	X	X	V	X	X	V	
	4096x2160 SMPTE	4096 x 2160	1.90			24	V	X	X	V	X	X	V
						25	V	X	X	V	X	X	V
						30	V	X	X	V	X	X	V
						50	V	X	X	V	X	X	V
						60	V	X	X	V	X	X	V
4K 3D (Passive 3D)	3840x2160	3840x2160	1.78	16:9	60	V	X	X	V	X	X	V	
4K 3D Dual Pipe (Passive 3D)						V	X	X	V	X	X	V	
High Frame Rate	1080p	1920x1080			240	V	X	X	V	X	X	V	

(V): Video format is supported.

(X): Video format is not supported.

Picture-in-picture/picture-by-picture (PIP/PBP) compatibility

The following table details the picture-in-picture/picture-by-picture (PIP/PBP) compatibility.

	HDMI-1	HDMI-2	Display Port	HDBaseT	12G-SDI
HDMI-1		V	V	V	V
HDMI-2	V		V	V	V
Display Port	V	V		V	V
HDBaseT	V	V	V		V
12G-SDI	V	V	V	V	

- (v): PIP/PBP combinations are enabled.

Regulatory

This product conforms to the following regulations related to product safety, environmental requirements and electromagnetic compatibility (EMC).

Safety

- IEC 62368-1:2018 - Audio/Video, Information And Communication Technology Equipment - Part 1: Safety Requirements
- EN/BS 62368-1:2014 + A11: 2017 - Audio/Video, Information And Communication Technology Equipment - Part 1: Safety Requirements
- UL 62368-1:2018 - Audio/Video, Information And Communication Technology Equipment - Part 1: Safety Requirements
- CSA CAN/CSA-22.2 No. 62368-1:2018 - Audio/Video, Information And Communication Technology Equipment - Part 1: Safety Requirements

Laser safety

- IEC/EN 62471-5 - Photobiological safety of lamps and lamp systems - Part 5: Image projectors
- IEC/EN 60825-1: 2014 - Safety of Laser Products - Part 1: Equipment Classification and Requirements

Electro-magnetic compatibility

Emissions

- FCC CFR47, Part 15, Subpart B, Class A - Unintentional Radiators
- CAN ICES-003 (A) / NMB-003 (A)
- CISPR 32/EN 55032, Class A – Electromagnetic Compatibility of Multimedia Equipment – Emission Requirements
- IEC 61000-3-2/EN61000-3-2 - Limits for Harmonic Current Emissions
- IEC 61000-3-3/EN61000-3-3 - Limitations of Voltage Changes, Voltage Fluctuations, and Flicker

Immunity

- CISPR 35/EN 55035 Electromagnetic compatibility of multimedia equipment - Immunity requirements

California law on security

- California Law Requiring Internet Connected Devices To Include Reasonable Security Features (California Civil Code Section 1798.91.04)

Environmental

- EU Directive (2011/65/EU) on the restriction of the uses of certain hazardous substances (RoHS) in electrical and electronic equipment and the applicable official amendment(s)
- EU Directive (2012/19/EU) on waste and electrical and electronic equipment (WEEE) and the applicable official amendment(s)
- Regulation (EC) No 1907/2006 concerning the Registration, Evaluation, Authorization and Restriction of Chemicals (REACH) and the applicable official amendment(s)
- China Ministry of Information Industry Order No.39 (02/2006) on the control of pollution caused by electronic information products, hazardous substances concentration limits (SJ/T11363-2006), and the applicable product marking requirement (SJ/T11364-2006)

