



User Guide

020-001725-03

Extreme Series LCD Panels

FHD554-XZ, FHD554-XZ-R, FHD554-XZ-H, FHD554-XZ-HR

CHRISTIE

NOTICES

COPYRIGHT AND TRADEMARKS

Copyright © 2020 Christie Digital Systems USA, Inc. All rights reserved.

All brand names and product names are trademarks, registered trademarks or trade names of their respective holders.

GENERAL

Every effort has been made to ensure accuracy, however in some cases changes in the products or availability could occur which may not be reflected in this document. Christie reserves the right to make changes to specifications at any time without notice. Performance specifications are typical, but may vary depending on conditions beyond Christie's control such as maintenance of the product in proper working conditions. Performance specifications are based on information available at the time of printing. Christie makes no warranty of any kind with regard to this material, including, but not limited to, implied warranties of fitness for a particular purpose. Christie will not be liable for errors contained herein or for incidental or consequential damages in connection with the performance or use of this material. Canadian manufacturing facility is ISO 9001 and 14001 certified.

WARRANTY

Products are warranted under Christie's standard limited warranty, the complete details of which are available by contacting your Christie dealer or Christie. In addition to the other limitations that may be specified in Christie's standard limited warranty and, to the extent relevant or applicable to your product, the warranty does not cover:

1. Problems or damage occurring during shipment, in either direction.
2. Problems or damage caused by combination of a product with non-Christie equipment, such as distribution systems, cameras, DVD players, etc., or use of a product with any non-Christie interface device.
3. Problems or damage caused by misuse, improper power source, accident, fire, flood, lightning, earthquake or other natural disaster.
4. Problems or damage caused by improper installation/alignment, or by equipment modification, if by other than Christie service personnel or a Christie authorized repair service provider.
5. Use of third party product enclosures for environmental protection during outside use must be approved by Christie.
6. Problems or damage caused by use of a product on a motion platform or other movable device where such product has not been designed, modified or approved by Christie for such use.
7. Except where the product is designed for outdoor use, problems or damage caused by use of the product outdoors unless such product is protected from precipitation or other adverse weather or environmental conditions and the ambient temperature is within the recommended ambient temperature set forth in the specifications for such product.
8. Image retention on LCD flat panels.
9. Defects caused by normal wear and tear or otherwise due to normal aging of a product.

The warranty does not apply to any product where the serial number has been removed or obliterated. The warranty also does not apply to any product sold by a reseller to an end user outside of the country where the reseller is located unless (i) Christie has an office in the country where the end user is located or (ii) the required international warranty fee has been paid.

The warranty does not obligate Christie to provide any on site warranty service at the product site location.

PREVENTATIVE MAINTENANCE

Preventative maintenance is an important part of the continued and proper operation of your product. Failure to perform maintenance as required, and in accordance with the maintenance schedule specified by Christie, will void the warranty.

REGULATORY (if applicable)

The product has been tested and found to comply with the limits for a Class A digital device, pursuant to Part 15 of the FCC Rules. These limits are designed to provide reasonable protection against harmful interference when the product is operated in a commercial environment. The product generates, uses, and can radiate radio frequency energy and, if not installed and used in accordance with the instruction manual, may cause harmful interference to radio communications. Operation of the product in a residential area is likely to cause harmful interference in which case the user will be required to correct the interference at the user's own expense. Changes or modifications not expressly approved by the party responsible for compliance could void the user's authority to operate the equipment.

CAN ICES-3 (A) / NMB-3 (A)

이 기기는 업무용(A급)으로 전자파적합등록을 한 기기이오니 판매자 또는 사용자는 이점을 주의하시기 바라며, 가정 외의 지역에서 사용하는 것을 목적으로 합니다.

ENVIRONMENTAL

The product is designed and manufactured with high-quality materials and components that can be recycled and reused. This symbol  means that electrical and electronic equipment, at their end-of-life, should be disposed of separately from regular waste. Please dispose of the product appropriately and according to local regulations. In the European Union, there are separate collection systems for used electrical and electronic products. Please help us to conserve the environment we live in!

Content

Package handling	7
Unpacking the panel.....	7
Inspecting the display panel.....	8
Handling and mounting guidelines for extreme narrow bezel series panels.....	9
Cleaning the panel.....	9
Key features.....	9
Parts list.....	10
Optional accessories.....	10
Product documentation.....	11
Related documentation.....	11
Important safeguards.....	12
General safety precautions.....	12
Remote Power Rack Shelf safety warnings (for FHD554-XZ-R & FHD554-XZ-HR).....	13
Controls and functions	14
Display at a glance.....	14
Input panel.....	15
Remote control unit.....	17
Installing a display panel	19
Inserting batteries in the remote control.....	19
Operating the remote control.....	19
Locking or unlocking the remote control.....	20
Mounting a display panel.....	20
Connecting signal to the display panel.....	20
Connecting to an AC power source (for FHD554-XZ and FHD554-XZ-H).....	21
Installing and configuring the Remote Power Rack Shelf (for FHD554-XZ-R and FHD554-XZ-HR) ..	21
Required tools.....	21
Mounting the Remote Power Rack Shelf.....	21
Inserting the power modules into the Remote Power Rack Shelf.....	22
Connecting the LCD display panel power cables to the Remote Power Rack Shelf.....	22
Logging in to the Remote Power Rack Shelf web interface.....	22
Changing the voltage of the rectifiers.....	23
Changing the IP address of the Remote Power Rack Shelf.....	23
Changing the time on the Remote Power Rack Shelf.....	24

- Setting the temperature units 24
- Resetting the breakers 25
- Connecting a display panel to a control system or a computer 25
 - Creating an RS232 connection..... 25
 - Creating an Ethernet connection..... 25
 - Creating an IR extender connection 26
- Connecting Source components to a display panel..... 26
 - Connecting a DisplayPort source..... 26
 - Connecting an HDMI source 27
- Creating a video wall 27
 - Connecting video by daisy-chaining display panels..... 27
 - Connecting an RS232 or an Ethernet controller to a video wall in landscape orientation 28
 - Connecting an RS232 or an Ethernet controller to a video wall in portrait orientation 29
 - The video wall height limits with OPS modules installed..... 29
- Turning on the display panel..... 33
- Avoiding image retention 33
- Configuring the on-screen display 34**
 - Changing the position of the on-screen display 34
 - Setting the on-screen display transparency 34
 - Changing the on-screen display timeout..... 34
 - Rotating the on-screen display..... 34
 - Changing the on-screen display language..... 35
- Setting up the system..... 36**
 - Adjusting the edges of the image of the display 36
 - Changing the behavior of the power LED..... 36
 - Disabling the OPS Always Powered setting 36
 - Changing the date and time 36
 - Scheduling when the display is on..... 37
 - Enabling CEC setting 37
 - Enabling DisplayPort Multi-Stream Transport (MST) 37
- Adjusting the image..... 38**
 - Changing the aspect ratio 38
 - Changing the image preset..... 38
 - Changing the contrast 38
 - Modifying the brightness..... 39
 - Sharpening the image..... 39

Adjusting the hue of the image	40
Changing the saturation.....	40
Changing the backlight	41
Changing the gamma settings	41
Calibrating the image	41
Setting the color temperature.....	42
Setting the RGB Adjust	42
Selecting the RGB Range.....	42
Updating display settings	43
Configuring the display settings	43
Selecting a source.....	43
Enabling Auto Scan	43
Enabling Multi-Source Views.....	43
Configuring advanced settings	44
Enabling IRFM	44
Turning off local dimming	45
Choosing Power Saving mode.....	45
Adjusting Edge Enhancement	45
Selecting DisplayPort version	45
Configuring EDID settings.....	45
Updating Multi-Display Control settings	46
Obtaining the temperature and fan status.....	47
Performing a factory reset	47
Configuring communications settings.....	47
Setting the baud rate	47
Configuring Ethernet settings	47
Enabling email alerts.....	48
Loading the network settings	48
Configure SNMP settings.....	49
Reading the IP address.....	49
Reading the device MAC address	49
Reading the system information.....	49
Recommended low-light image settings	50
Troubleshooting.....	51
The display does not turn on	51
The remote control does not work.....	51

The image geometry is incorrect	51
The content is jittery or unstable.....	52
The image is too bright or lacks definition	52
The image appears washed out.....	52
The image is too dark	52
Images from the HDMI source do not display.....	52
Computer images do not display correctly	53
Specifications	54
Physical specifications.....	54
Power requirements	55
Environmental specifications.....	56
Supported timings.....	57
Overall dimensions	60
Regulatory	62
Safety	62
Electro-magnetic compatibility.....	62
Environmental	62

Package handling

Learn how to remove the display panel from the packaging and how to handle the display panel.

Unpacking the panel

Learn how to remove the panel from the packaging.

Each LCD panel is packed inside a box carton. To protect the panel during transportation, additional packing material has been placed within the carton.

1. Before unpacking, prepare a stable, level, and clean surface near a wall outlet.

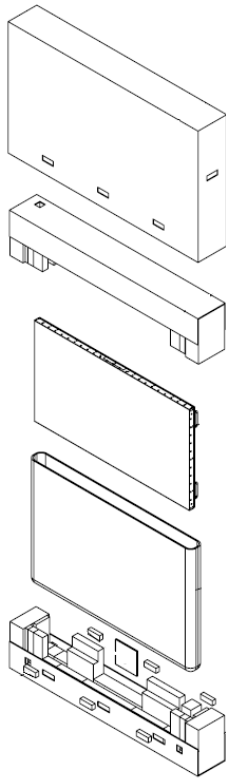

2. Set the box in an upright position and pull out the white carton locks.
3. Lift up the top cover carton.
4. Remove the polybag before removing the display from the bottom tray carton.
5. Remove any additional packaging, such as protective stickers, from the display panel.

Inspecting the display panel

Conduct an inspection on the display panel and verify the panel functions as expected before unpacking. If any damage is identified, or the panel does not function as expected, contact Christie Technical Support.

1. Tear off the sticker for a small opening on the right bottom corner at the back of the display panel (A).

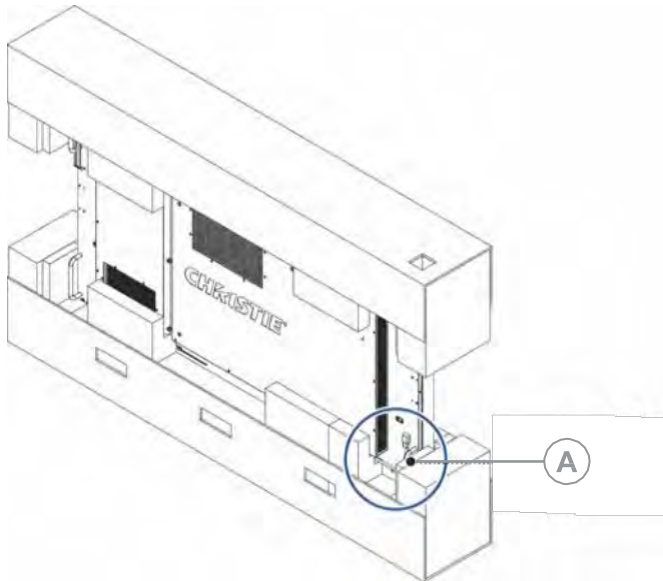

2. Pull the power cable through the packaging.
3. Connect the power cord to a power source and turn on the display panel.

For AC models, pull out the extended power cable and connect it to an AC power cord.

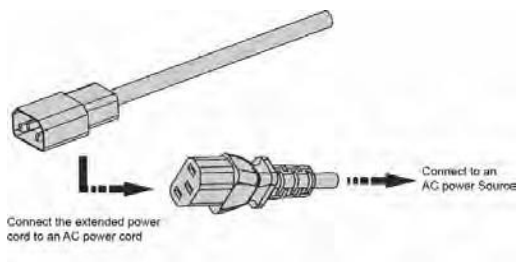

For DC models, pull out the DC power cord.

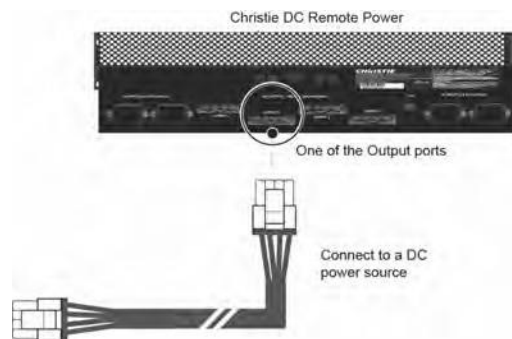

When connecting to a power source for the first time, the display panel automatically cycles through test patterns for 15 minutes (only).

4. As the display panel is cycling through the test patterns, inspect the display.

Handling and mounting guidelines for extreme narrow bezel series panels

Follow these best practices when handling and mounting extreme narrow bezel panels.



Notice. If not avoided, the following could result in property damage.

- When moving the panel, always use the handles. Do not carry the panel by the frame.
- Do not twist, bend, or tilt the panel.
- Do not apply excessive force to the sides of the bezel when mounting the panel or pushing into its locked position.
- Always handle the display panel from the sides or handles.

Follow the following guidelines before removing the panel from the packaging.

- To verify normal operation before handling, power on the panel in the packaging.
- Always use the handles to pick up and carry the panel.
- Leave the panel in the box until the mount is on the wall and you are ready to install the panel.
- To avoid putting undue stress on the panel when mounted, make sure the mount is square, flat, and level.
- Do not rest panels on top of a lower panel.
- When inserting the panel into the wall, pay close attention to adjacent panels.
- Make sure there is a minimum of 0.5 mm between mounted panels to allow for thermal expansion.

Cleaning the panel

Learn how to clean the display panel.

After disconnecting the power cable, wipe contaminated parts and each part of the product screen lightly with a dry and soft cloth.

Do not use a liquid, spray cleaners, or any abrasive cleaners to clean the LCD panel.

Washing with various cleaning agents, brighteners, abrasives, waxes, benzene, alcohol, solvent, surface active agent, may damage the surface of the product.

Key features

Learn the key features of the display panel.

- FHD native resolution: 1920 x 1080 (16:9 native aspect ratio)
- High brightness: FHD554-XZ and FHD554-XZ-R - up to 500 nits
FHD554-XZ-H and FHD554-XZ-HR - up to 700 nits
- 178-degree viewing angle
- DisplayPort 1.2, HDMI 2.0 and DisplayPort 1.2 output with High-bandwidth Digital Content Protection (HDCP) 2.2
- DisplayPort 1.2 output to support daisy-chaining UHD content (3840x2160) up to 25 display panels, regardless of which digital input connector is used first

- Video wall resolution up to 3840 x 2160 (UHD)
- Displays native 4K content at 60 Hz on a 2x2 video wall for sources that support Multi-Stream Transport (MST)



Multi-Stream Transport (MST) requires a video card that supports this feature and DisplayPort 1.2.

- Video signal looping
- Direct LED backlight
- Video Wall Toolbox 2.0 software simplifies the setup of a large video wall, with up to 100 displays, using a Windows PC
- Portrait and Landscape compatible
- OPS slot

Parts list

Your display panel is shipped with the following items. If any items are missing or damaged, contact your dealer.

- Remote control unit and batteries
- DC daisy-chain power cable—1.8m (for FHD554-XZ-R & FHS554-XZ-HR)
- DisplayPort cable—1.8m
- CAT5 cable—2m
- IR extender cable—1.8m
- AC power cord (for FHD554-XZ & FHD554-XZ-H)
- Product safety guide
- Spacer tool—Qty 2 (P/N: 003-006724-XX)

Optional accessories

The following accessories are available for the display panel:

For FHD554-XZ & FHD554-XZ-H:

- ML25 Thin Profile LCD Video Wall Mount
- MPL15 LCD Video Wall Mount
- Trim Kit Long 554 MPL15
- Trim Kit Short 554 MPL15
- Trim Kit Long 554 ML25
- Trim Kit Short 554 ML25

For FHD554-XZ-R & FHD554-XZ-HR:

- Remote Power Supply Unit Shelf

- Power Supply Unit Module
- Main Power Cable 6m (20')
- Main Power Cable 15m (50')
- Main Power Cable 30m (100')
- Main Power Cable 50m (164')
- Main Power Cable 75m (246')
- Main Power Cable 160m (525')
- Crimping tool for Main Power Cable connectors
- Connector Kit for Main Power Cable
- AC Line Cord
- ML25 Thin profile LCD Video Wall Mount
- MPL15 LCD Video Wall Mount
- Trim Kit Long 554 MPL15
- Trim Kit Short 554 MPL15
- Trim Kit Long 554 ML25
- Trim Kit Short 554 ML25

Product documentation

For installation, setup, and user information, see the product documentation available on the Christie website. Read all instructions before using or servicing this product.

1. Access the documentation from the Christie website:
 - Go to this URL: <http://bit.ly/2CqwJJO>
 - Scan the QR code using a QR code reader app on a smartphone or tablet.



2. On the product page, select the model and switch to the Downloads tab.

Related documentation

Additional information on the LCD panels is available in the following documents.

- *Extreme Series LCD Panels Product Safety Guide (P/N: 020-001724-XX)*
- *Extreme Series LCD Display Panels External Commands (P/N: 020-001684-XX)*
- *Extreme Series LCD Panels Service Guide (P/N: 020-001733-XX)*
- *Using the Video Wall Toolbox (P/N: 020-001662-XX)*
- *Color Matching a Video Wall (P/N: 020-001663-XX)*

Important safeguards

To prevent personal injury and to protect the device from damage, read and follow these safety precautions.

General safety precautions

Observe these important safety rules to avoid personal injury or damage to the product.



Warning! If not avoided, the following could result in death or serious injury.

- Ensure that any external equipment is properly grounded before connecting to the display device.
- A minimum of two people or appropriately rated lift equipment is required to safely lift, install, or move the product.
- Do not drop the product.
- Do not apply excessive force to the sides of the bezel when mounting the panel or pushing into its locked position.
- Always handle the product on the opposing corners of the bezel to avoid direct contact with the glass.
- TIP HAZARD! When shipping a panel, use the provided packing materials and secure to a pallet.
- When moving the panel, always use the handles. Do not carry the panel by the frame.



Caution! If not avoided, the following could result in minor or moderate injury.

- Do not tilt the product more than ± 15 degrees.
- Use the handles when moving the shipping package.
- Do not twist, bend, or tilt the panel.



Notice. If not avoided, the following could result in property damage.

- Only clean the components with Christie approved products.

Remote Power Rack Shelf safety warnings (for FHD554-XZ-R & FHD554-XZ-HR)

To prevent personal injury and to protect the device from damage, read and follow these safety precautions.



Warning! If not avoided, the following could result in death or serious injury.

- This product must be installed within a restricted access location not accessible by the general public.
- SHOCK HAZARD! Disconnect the product from AC before installing, moving, servicing, cleaning, removing components, or opening any enclosure.
- A minimum of two people or appropriately rated lift equipment is required to safely lift, install, or move the product.
- A certified electrician must be present during installation to ensure the installation meets the local electrical code.
- Install the product near an easily accessible AC receptacle.
- Hazardous voltages are present at power system inputs. The DC output, though not dangerous in voltage, has a high short-circuit current capacity that may cause severe burns and electrical arcing.
- SHOCK HAZARD! Power supply uses double pole/neutral fusing.
- Before working with live power systems, remove all metallic jewelry (such as watches, rings, metal rimmed glasses, or necklaces) and wear safety glasses with side shields at all times during the installation.
- Motors and fans may start without warning.
- Use insulated hand tools while working on live power systems.

Controls and functions

Learn about the various parts and functions of the LCD panel.

Display at a glance

Learn about the key display components.

FHD554-XZ & FHD554-XZ-H

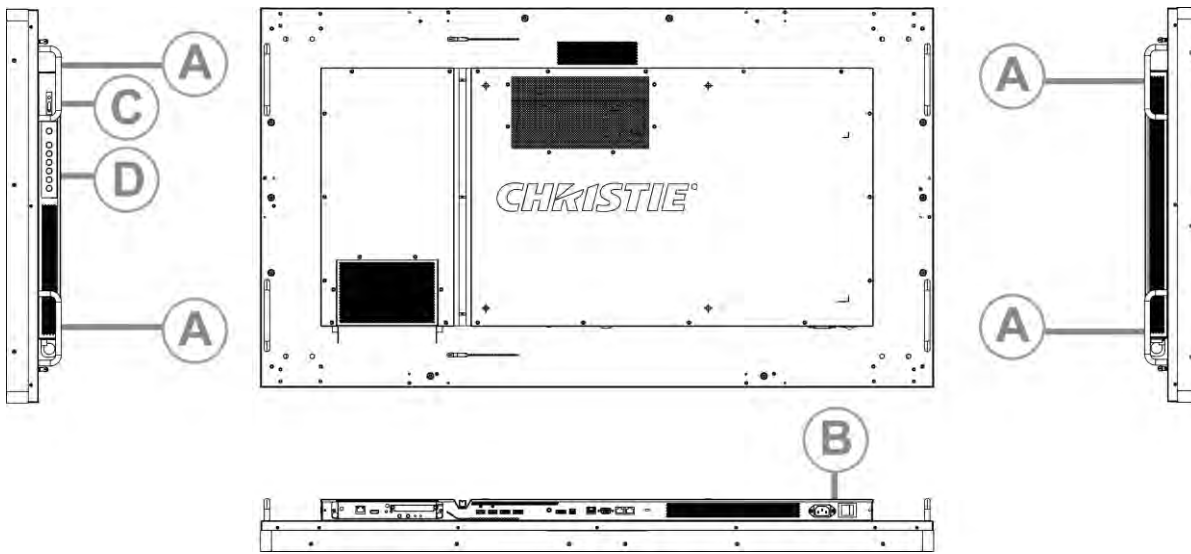

FHD554-XZ-R & FHD554-XZ-HR

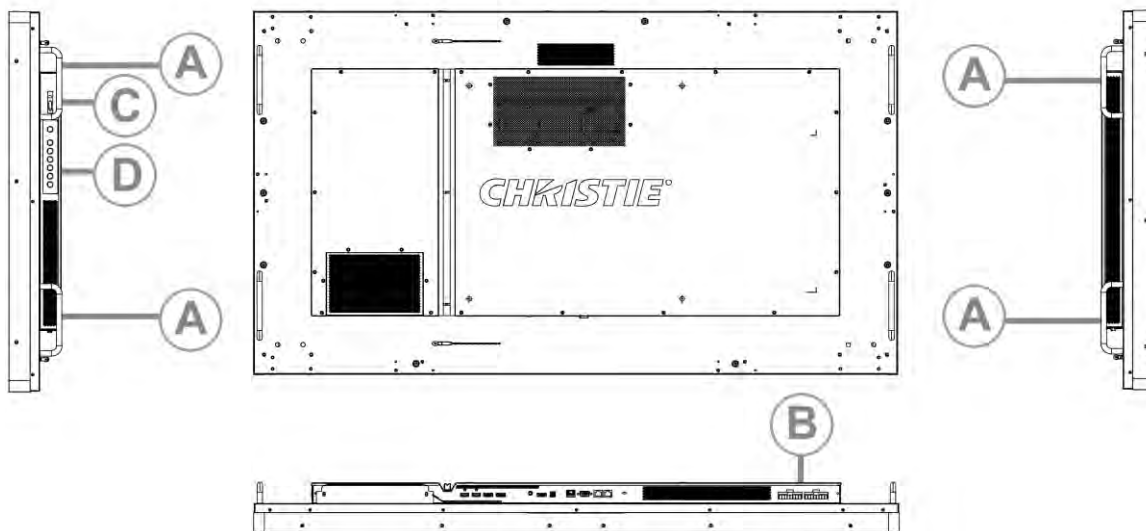

A	Handles—Always use the handles when carrying the display. Do not touch or hold the screen face or panel edges.
B	Main power interface—Connects or disconnects the display panel from the power source.
C	Status LED / IR receiver—Lights orange to indicate that the display is in standby mode; blinks orange if no input signal is present; off if the main power switch is set to Off. The IR receiver receives commands from the IR remote control.
D	Keypad—You can use the keypad instead of the remote control unit to operate the on-screen display (OSD) controls. The keypad operates as follows: On/Standby—Press once to toggle from Standby mode to On mode. Press it again to return to Standby mode. SOURCE—To select a source, press the SOURCE button repeatedly (with no menus visible on-screen). Right key—When a menu is visible on-screen, this button operates identically to the right-arrow (or ENTER) button on the display remote control unit. Left key—When a menu is visible on-screen, this button operates identically to the left-arrow button on the display remote control unit. Up and down keys—When a menu is visible on-screen, these buttons operate identically to the up and down-arrow buttons on the display remote control unit. MENU/EXIT—Press this button to access the on-screen display (OSD) controls, or to exit the current menu and return to the previous one.

Input panel

Learn the components of the display input panel.

FHD554-XZ & FHD554-XZ-H

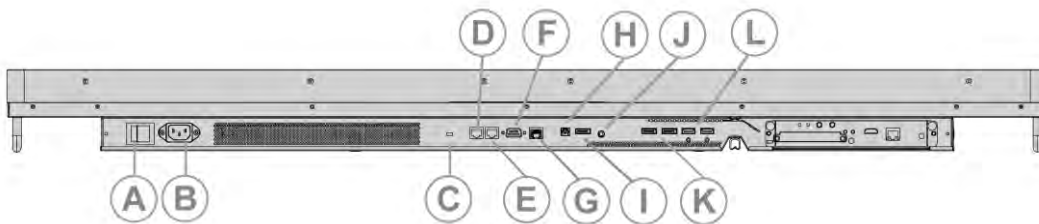

FHD554-XZ-R & FHD554-XZ-HR

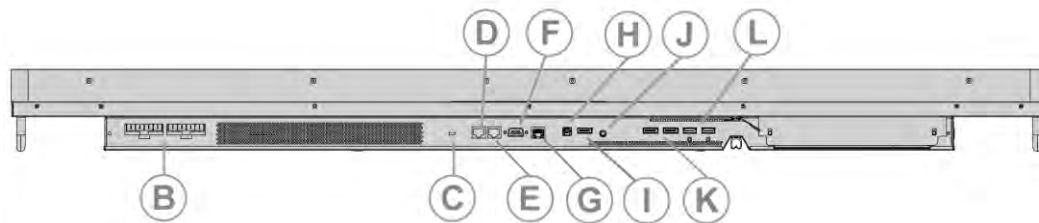

A	Power Switch—Turn the display panel on or off. (for FHD554-XZ & FHD554-XZ-H)
B	Power Input—Connect the display panel to power here. FHD554-XZ & FHD554-XZ-H — 100 to 240 VAC; FHD554-XZ-R & FHD554-XZ-HR — 58 VDC
C	Kensington Lock Slot—For use with a Kensington lock (sold separately) for securing the display panel.
D	RS485 Out—A female, 8-pin RJ-45 connector that connects to the next display panel in a video wall. For more information about creating a video wall, see <i>Creating a video wall</i> (on page 27).

E	RS485 In—A female, 8-pin RJ-45 connector that connects to the next video source. For more information about creating a video wall, see <i>Creating a video wall</i> (on page 27).
F	RS232 In—A female, 9-pin D-sub connector for interfacing with a PC or a home theater automation or control system.
G	Ethernet—An RJ-45 connector for connecting to a computer or a home theater system over a wired Ethernet network.
H	SPDIF Out—Connects external and powered digital speakers or audio receiver/amplifier.
I	DP Out—DisplayPort 1.2 and HDCP-compliant digital video output for connecting the display panel to the next display panel in a video wall. This output can be used with DP or HDMI inputs. For more information about creating a video wall, see <i>Creating a video wall</i> (on page 27).
J	IR In—An IR receiver sensor that sends information from an infrared remote control to another device by receiving and decoding signals.
K	DP In 1, 2 —DisplayPort 1.2 and HDCP-compliant digital video input for connecting DisplayPort sources.
L	HDMI 1, 2—Two HDCP-compliant digital video inputs for connecting HDMI sources.

Remote control unit

Learn the functions of the remote control.

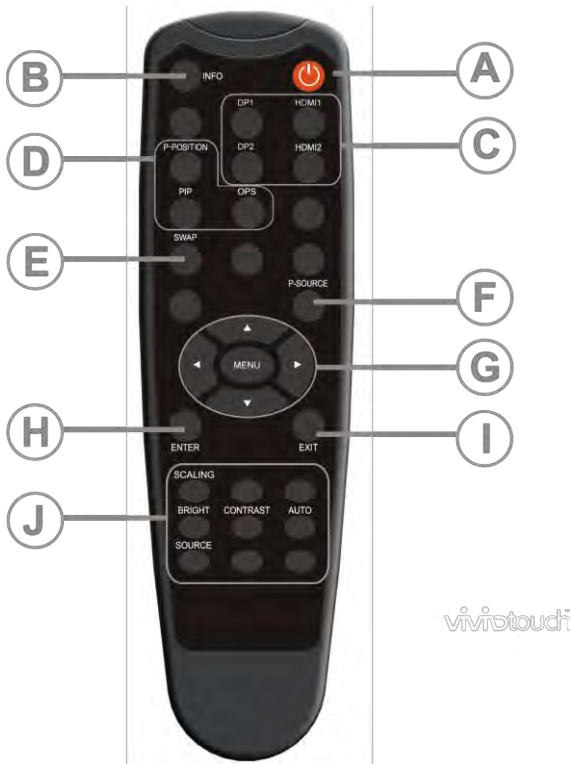

A	Power—Turns the display panel on or off.
B	INFO—Provides source and resolution information.
C	Sources <ul style="list-style-type: none"> • DP1—Selects the DisplayPort source 1. • DP2—Selects the DisplayPort source 2. • HDMI 1—Selects the HDMI source 1. • HDMI 2—Selects the HDMI source 2.
D	Display options <ul style="list-style-type: none"> • P-Position—Selects the PIP position. • PIP—Turns the PIP feature on or off. • OPS—Selects the OPS source.
E	Swap—Swaps the main and PIP source.
F	P-Source—Selects the secondary sub-source.
G	Navigation buttons

	<ul style="list-style-type: none"> • MENU—Opens the monitors on-screen menu system. If the menu is already open, pressing this button selects the previous submenu. • Arrow Keys—Navigate through submenus and settings.
H	ENTER—Selects highlighted menu choices.
I	EXIT—Closes the menu system.
J	<p>Image adjustments</p> <ul style="list-style-type: none"> • SCALING—Selects each aspect ratio in sequence: Full Screen, Native, Letter Box and 4:3. • BRIGHT—Adjusts the brightness. • CONTRAST—Adjusts the contrast. • SOURCE—Selects each source in sequence.

Installing a display panel

Learn how to install and configure the display panel and the remote control.

Christie recommends that the ambient temperature around a display panel or a video wall remain constant and below 40 degrees Celsius (104 degrees Fahrenheit). Ensure the display panel or video wall is kept away from heating and air conditioning vents.

If you are mounting a display panel in an enclosure, ensure sufficient space is left on all sides between it and surrounding objects. Doing so allows heat to disperse, and helps to maintain the proper operating temperature. If you are mounting a display panel close to a wall, or are using an OPS module, active cooling may be required to remove heat and maintain an ideal ambient temperature.

For thin installations or to mount the display close to a wall, remove the handles after hanging the display on the extending wall mount by turning the handles counter-clockwise.

Inserting batteries in the remote control

Learn how to install batteries in the remote control.

Before you insert batteries in the remote control, consider the following:

- Ensure that the battery polarities are correct.
- Do not mix an old battery with a new one or mix different types of batteries together.
- Do not expose batteries to excessive heat such as sunlight or fire.

If you will not use the remote control for a long time, consider removing the batteries to avoid damage from battery leakage.

1. On the back of the remote control, press down on the tab on the cover and pull the cover up.
2. Insert the batteries. Ensure that the polarities correctly match the + and - markings inside the battery compartment.
3. Insert the lower tab of the cover into the opening, and press down on the cover until it clicks in place.

Operating the remote control

To install batteries in the remote control:

- Verify that nothing is obstructing the infrared beam between the remote control and the IR receiver on the display panel.
- If the effective range of the remote control decreases, or it stops working entirely, replace the existing batteries with new ones.
- If necessary, use an IR extender to move the IR receiver to a more convenient place. For more information, see *Creating an IR extender connection* (on page 26).
- If the infrared remote sensor is exposed to bright sunlight or fluorescent lighting, the remote control might become unresponsive.
- Ambient conditions might impede the operation of the remote control. If this occurs, point the remote control directly at the display panel and repeat the desired operation.

Locking or unlocking the remote control

Lock or unlock the remote control buttons to prevent unauthorized individuals from changing the display settings.

1. On the remote control, press ENTER > ENTER > EXIT > EXIT > ENTER > EXIT to lock the remote control.
2. To unlock the remote control, enter the same sequence of commands.

Mounting a display panel

Use only the approved wall-mount kit designed for your display panel.



Caution! If not avoided, the following could result in minor or moderate injury.

- TIP HAZARD! Center align the product on the stand or mount.

If you decide to wall-mount a display panel, ensure that the wall-mount bracket is installed according to the instructions that are included with it. The wall must be capable of supporting three times the weight of the display panel or be reinforced.

To ensure the mounting brackets clear any protrusions on the rear of the panel, Christie recommends using spacers with a minimum height of 6.35 mm (.25 in).

Mounting brackets may block access to the connector ports. To ensure the preferred mount allows access to the connectors, refer to the display panel line drawings on www.christiedigital.com for measurements.

At the location where the space between tiles is the tightest, use the spacer tool to ensure there is a minimum of 0.5mm, or the thickness of a credit card, between adjacent LCD display panels.

Connecting signal to the display panel

You can connect a display panel to video sources, external controllers, and power sources. Follow these guidelines when you connect equipment to a display panel.

- Turn off all equipment before making any connections.
- Use the correct signal cables for each source.
- For best performance and to minimize cable clutter, use high-quality cables that are only as long as necessary to connect two devices. For example, avoid using a 20-foot cable if a 6-foot cable is sufficient.
- Ensure that the cables are securely connected. Tighten all thumbscrews on connectors that have them.

Connecting to an AC power source (for FHD554-XZ and FHD554-XZ-H)

Use the power cord that comes with the display panel to connect the panel to an external power source, such as an AC wall outlet.

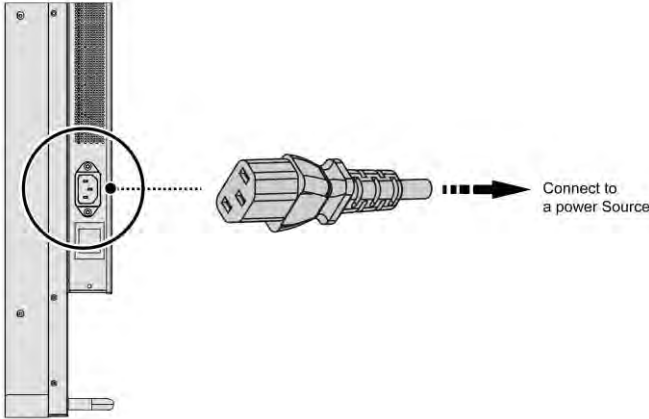

Installing and configuring the Remote Power Rack Shelf (for FHD554-XZ-R and FHD554-XZ-HR)

Use the following instructions to install and configure the Remote Power Rack Shelf external power supply.

Required tools

Make sure the following tools are available during the installation.

Remote Power Rack Shelf installation tools

- Screwdrivers
- Molex Crimping Tool (P/N: 154-124108-XX)

If the power cord supplied with your product is not long enough to connect the first display panel in an array to the Remote Power Rack Shelf module, you must purchase a power cord of an adequate length. Christie recommends one of the pre-terminated power cables offered as Christie accessories, or that you create a custom cable using the Christie Main Power Cable Spool (P/N 154-122106-XX), Connector Kit (P/N 154-125109-XX), and Molex Crimping Tool (P/N 154-124108-XX). For more information on the Molex Crimping Tool, see the Molex documentation.

Mounting the Remote Power Rack Shelf

The power system must be mounted in a clean and dry environment. Sufficient free space must be provided at the front and rear of the power system.



Warning! If not avoided, the following could result in death or serious injury.

- This product must be installed within a restricted access location not accessible by the general public.

1. Find a location in the rack for a 3U device.

2. Attach the Remote Power Rack Shelf to the rack.

Inserting the power modules into the Remote Power Rack Shelf

The power modules, or rectifiers, convert an AC power source into the DC current required by the product.

1. Remove the cover from the rectifier slot.
2. Slide the power module into the front of the chassis until it clicks into place.
3. To lock the power module, lift the handle and snap it into place.
4. Repeat steps 1 to 3 for each rectifier in the Remote Power Rack Shelf.

Connecting the LCD display panel power cables to the Remote Power Rack Shelf

To power the FHD554-XZ-R and FHD554-XZ-HR panels, connect the cables between the LCD panels and the Remote Power Rack Shelf.

1. Connect the main power cable to the Remote Power Rack Shelf.
2. Connect the LCD panel cable to the main power cable.

If the power cord supplied with your product is not long enough to connect the first display panel in an array to the Remote Power Rack Shelf module, you must purchase a power cord of an adequate length. Christie recommends one of the pre-terminated power cables offered as Christie accessories, or that you create a custom cable using the Christie Main Power Cable Spool (P/N 154-122106-XX), Connector Kit (P/N 154-125109-XX), and Molex Crimping Tool (P/N 154-124108-XX). For more information on the Molex Crimping Tool, see the Molex documentation.

3. To connect one display panel to another, connect the DC daisy-chain power cord to the Out port of a panel, then connect the other end of the power cord to the In port of another panel, within specified system limits.

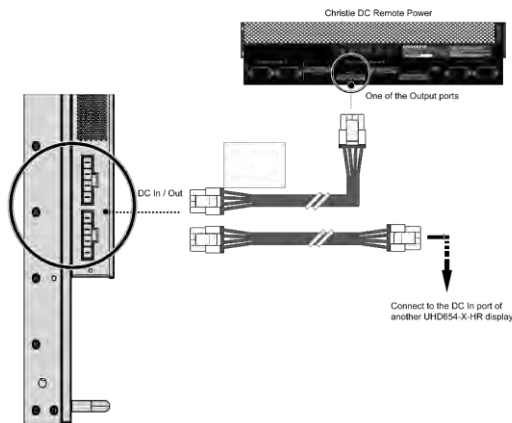

4. Plug the Remote Power Rack Shelf into the building outlets in the wall or the floor.

Logging in to the Remote Power Rack Shelf web interface

To make changes to the Remote Power Rack Shelf, use Internet Explorer.

1. Connect a computer to the Remote Power Rack Shelf with a network crossover cable.
2. To access the web interface, in the Control Panel, change the IP address and subnet mask of the computer to be on the same subnet as the Remote Power Rack Shelf.

If the IP address and subnet mask on the Remote Power Rack Shelf have not been changed from the default, use the following values on the computer:

- IP address: 10.10.10.202
- Subnet mask: 255.255.255.0

3. Turn off any browser pop-up blockers.
4. In the browser address bar, type the IP address of the Remote Power Rack Shelf device.

The default IP address is 10.10.10.201.

If you have changed the IP address of the Remote Power Rack Shelf, the IP address and subnet mask of the computer must also be changed.

The IP address for the web interface is one digit higher than the IP address of the device. For example, when the IP address of the device is 10.10.10.201, the address of the web interface is 10.10.10.202.

5. If prompted, run the MSXML add-on.
6. Log in to the Remote Power Rack Shelf with your username and password.

The default username is Admin, and the default password is 1234.

Changing the voltage of the rectifiers

Change the output voltage to the preferred voltage.

1. *Log in to the Remote Power Supply Rack Shelf web interface (on page 22).*
2. Select Rectifiers > Configure Rectifiers.
3. Change the Float Voltage field to the preferred voltage.
The recommended voltage range is 48 VDC - 58 VDC.
4. Ensure the Safe Voltage and Over Voltage Protection (OVP) fields are set properly for the new voltage.

The below is the nominal (Default) settings:

- Float voltage: 48 VDC
- Equalize voltage: 49 VDC
- Safe voltage: 48.5 VDC
- OVP: 59 VDC
- HVA: 55.5 VDC

5. Click Submit Changes.

Changing the IP address of the Remote Power Rack Shelf

In an environment where there are multiple Remote Power Rack Shelf devices, you must have a unique IP address for each device.

1. Select Communications > Configure Communication Parameters.
2. Set the new IP address for the Remote Power Rack Shelf.
3. Click Submit Changes.

After the IP address has been changed from the web interface, close the browser window and then open it using the new IP address.

If you have changed the IP address of the Remote Power Rack Shelf, the IP address and subnet mask of the computer must also be changed.

Resetting the Remote Power Rack Shelf IP address

The Remote Power Rack Shelf IP address ensures local access with a laptop and a standard network crossover cable.

1. Press and hold the front panel reset button (RST) for three seconds.

The Remote Power Rack Shelf beeps three times, the IP address is reset to 10.10.10.201, and DHCP is disabled.

Changing the time on the Remote Power Rack Shelf

Configure the time on the Remote Power Rack Shelf.

The date and time is a dynamic field, and as changes are made to the values on the screen the internal values are also changed. An event is added to the event log detailing the changes made.

1. Log in to the Remote Power Rack Shelf web interface.
2. Select Controller > Date and Time.
3. Set the date and time for the Remote Power Rack Shelf.
 - Manually enter the date and time for the Remote Power Rack Shelf to use.
 - Automatically retrieve the date and time from a server.
 - a. Select Enable SNTP Service.
 - b. Type the IP address of the SNTP source.
 - c. In the Time Zone Adjustment field, select the time zone adjustment for the location of the Remote Power Rack Shelf.
4. Click Save.
5. If the time is set by an SNTP service, click Get Time Now.

Setting the temperature units

Change the units used when reporting the temperature.

1. Log in to the Remote Power Rack Shelf web interface.
2. Select Controller > Temperature Units.
3. Select whether the display units are Celsius or Fahrenheit.
4. Click Save.

Resetting the breakers

When too many components are connected or too much power is sent through the Remote Power Rack Shelf, the breakers may interrupt the current flow. Reset the breakers to resume operation.

If the breakers disconnect the current, the On button is released for the affected Output.

1. Reduce the number of panels connected to the input or the amount of power going through the input.
2. Push the On button back into place.

The current is reconnected, and the output is powered.

Connecting a display panel to a control system or a computer

Learn how to create an RS232, an Ethernet, or an IR extender connection.

Creating an RS232 connection

A straight-through RS232 cable with a 9-pin male connector is required.

1. Connect the RS232 cable to the RS232 port on the display panel.
2. Connect the RS232 cable to the control computer.

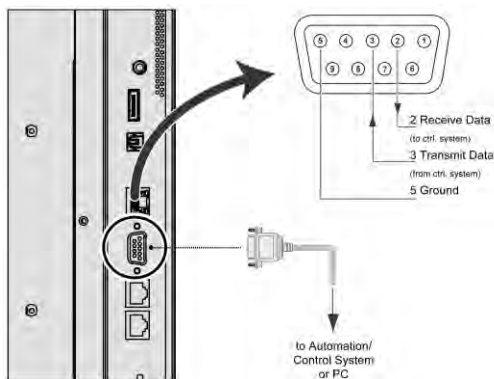

Creating an Ethernet connection

Use a standard Ethernet cable with an RJ45 male connector.

1. Connect the Ethernet cable to the Ethernet port on the display panel.

2. Connect the Ethernet cable to the control computer.

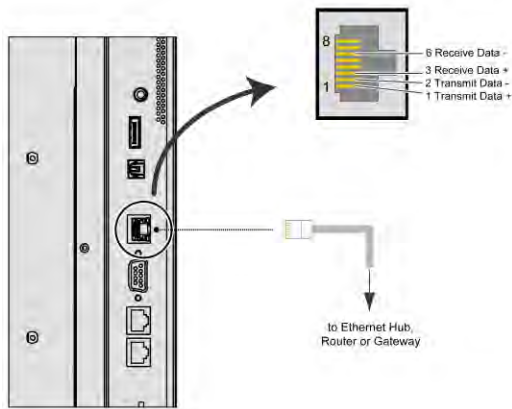

Creating an IR extender connection

Learn how to connect an IR extender cable to a display panel.

1. Connect the IR extender cable to the IR extender input on the display panel.
2. Place the extender cable receiver in a location that can be detected by the remote.

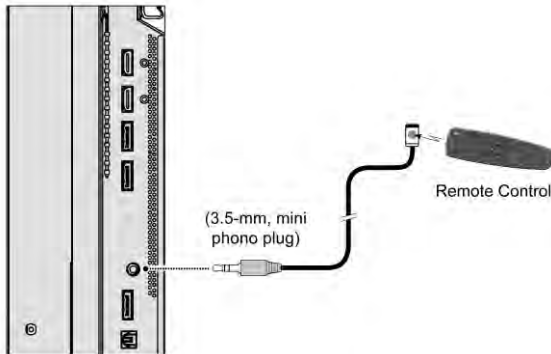

Connecting Source components to a display panel

Learn how to connect video sources to a display panel.

Connecting a DisplayPort source

Learn how to connect a control computer to a display panel using a DisplayPort source.

1. Connect the DisplayPort cable to the DisplayPort in port on the display panel.

2. Connect the DisplayPort cable to the control computer.



If you are using Multi-Stream Transport (MST), DisplayPort 1.2 input and output can support daisy-chaining up to four display panels.

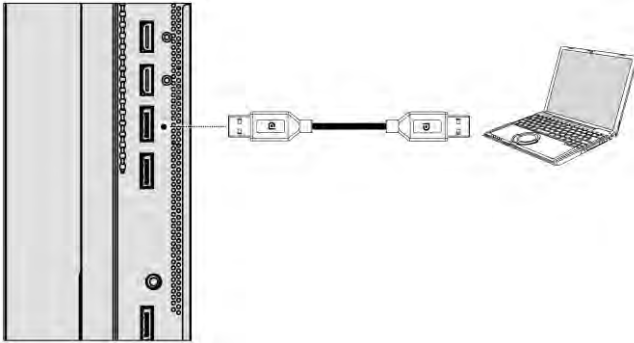

Connecting an HDMI source

Learn how to create a connection using an HDMI source.

1. Do one of the following.
 - Connect an HDMI or a DVI-to-HDMI cable to the HDMI port on the display panel.
2. Connect the cable to the control computer.

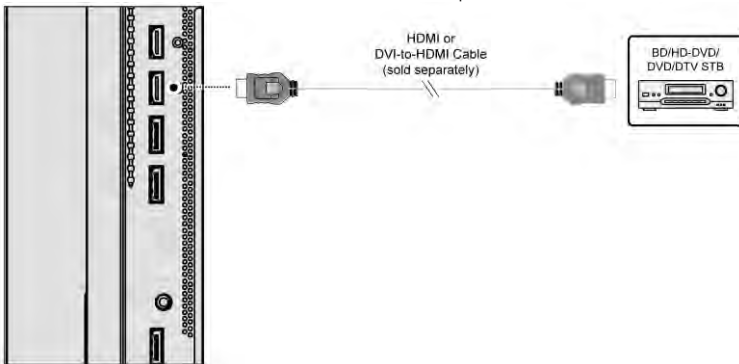

Creating a video wall

Learn how to set up an array of display panels in a video wall. For more information of color matching settings, refer to *LCD Panel Color Matching Guide – UHD654-X-HR and Extreme Series (P/N: 020-001663-XX)* on the Christie website.

Connecting video by daisy-chaining display panels

If you are using Multi-Display Control commands, all display panels in a video wall should receive the same video signal.

You can do this using an external video splitter, or by daisy-chaining up to 25 display panels together using the DP Out connector.

If you are daisy-chaining the display panels together, consider the following:

- The DP Out connector on a display panel performs the same function as an external video splitter.
- The DP Out connector functions as a repeater for all digital inputs, including HDMI 1 In, HDMI 2 In, DP1 In and DP2 In.
- To daisy-chain display panels, connect a digital source to the first panel in the video wall.
- Subsequent display panels can be connected using the DisplayPort cable using the upstream DP Out and the downstream DP In connections.
- The maximum number of display panels that can be daisy-chained using the DP Out connector is 25.
- If more than 25 display panels are required, daisy-chaining can be used in combination with an external video splitter.

When color matching the display panels, use native or uncorrected sources and a test pattern from an external source.

1. To daisy-chain video throughout a video wall using a single video source, connect the HDMI or DisplayPort video source to the first display panel in the video wall.
2. Connect the remaining display panels using the DP out of the upstream display panel and the DP In of the downstream display panel.

Connecting an RS232 or an Ethernet controller to a video wall in landscape orientation

Complete the following steps to connect an RS232 or an Ethernet controller to a video wall in landscape orientation.

It is not recommended that more than 25 display panels be daisy-chained together using the RS485 input and outputs. If you are working with a video wall that exceeds 25 display panels, consider breaking the video wall into groups of 25 display panels or less, and then use separate RS232 or Ethernet connections to control each group.

To control a video wall using the IR remote control, plug the IR extender into the first display panel in the daisy-chain.

1. Connect the controller to the top-left or bottom-left display panel.
2. Connect the remaining panels as illustrated.

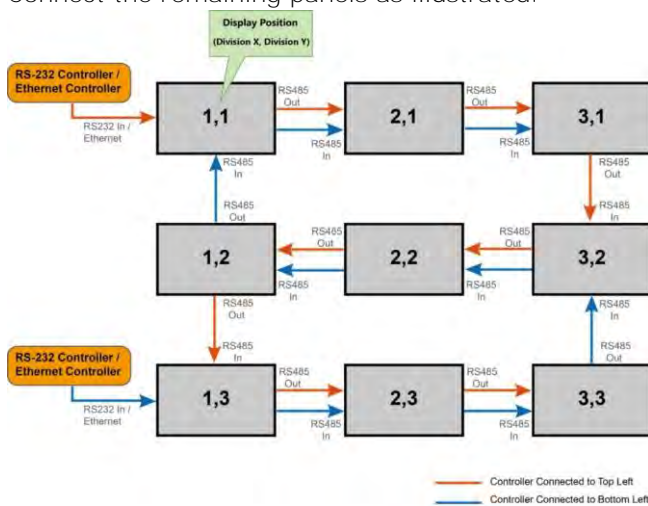

Connecting an RS232 or an Ethernet controller to a video wall in portrait orientation

Complete the following steps to connect an RS232 or an Ethernet controller to a video wall in portrait orientation.

It is not recommended that more than 25 display panels be daisy-chained together using the RS485 input and outputs. If you are working with a video wall that exceeds 25 display panels, consider breaking the array in to groups of 25 display panels or less, and then use separate RS232 or Ethernet connections to control each group.

When you create a video wall in portrait orientation, both the video source and the content must be configured for use in a 9:16 format.

1. Connect the controller to the top-left or the top-right display panel.

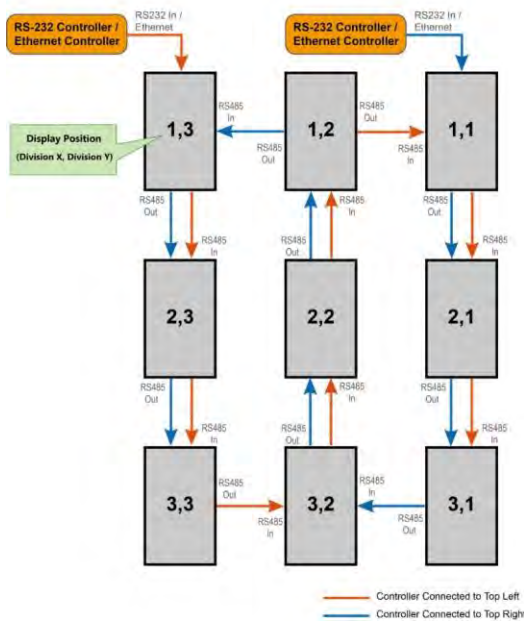

2. Connect the remaining panels as illustrated.

The video wall height limits with OPS modules installed

To keep displays and OPS modules within safe thermal operating limits, video walls should not exceed the sizes shown below:

Installation note for OPS module:

- Always use screws to install OPS
- Max power draw: 96W
- Do not hot swap

FHD554-XZ & FHD554-XZ-H

Case 1. Without OPS module

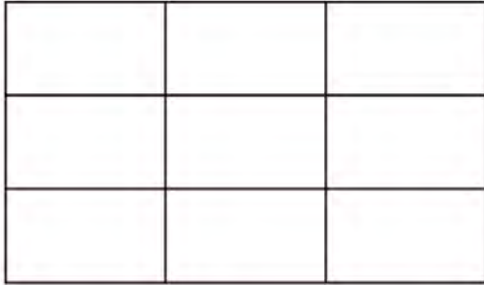

Table of MAX. rows in height

		Wall Mount Clearance					
		5mm (ADA)	1 inch	2 inch	3 inch	4 inch	>5 inch
Operating Temperature (°C)	25	5	5	6	8	10	10
	30	4	5	5	7	10	10
	35	4	4	5	6	8	10
	40	3	3	4	5	7	10

Case 2. With one OPS module installed

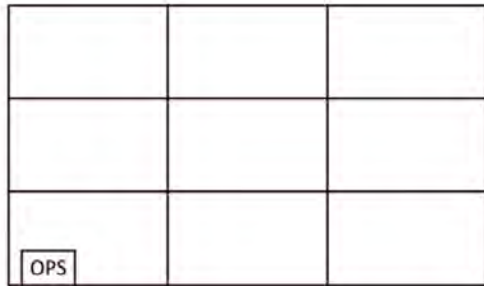

Table of MAX. rows in height

		Wall Mount Clearance					
		5mm (ADA)	1 inch	2 inch	3 inch	4 inch	>5 inch
Operating Temperature (°C)	25	5	5	6	8	10	10
	30	4	5	5	7	10	10
	35	4	4	5	6	8	10
	40	3	3	4	5	7	10

Case 3. With one row OPS modules installed (only the bottom row)

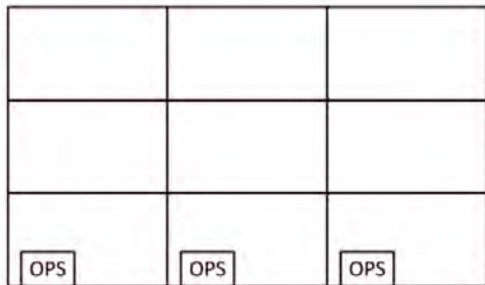

Table of MAX. rows in height

		Wall Mount Clearance					
		5mm (ADA)	1 inch	2 inch	3 inch	4 inch	>5 inch
Operating Temperature (°C)	25	5	5	6	8	10	10
	30	4	5	5	7	10	10
	35	3	4	5	6	8	10
	40	3	3	4	5	7	10

Case 4. With OPS modules installed in every odd row

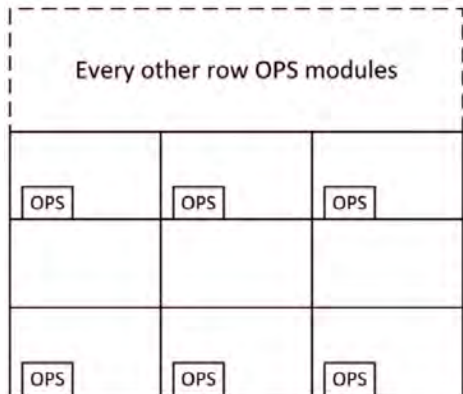

Table of MAX. rows in height

		Wall Mount Clearance					
		5mm (ADA)	1 inch	2 inch	3 inch	4 inch	>5 inch
Operating Temperature (°C)	25	4	4	6	8	10	10
	30	4	4	4	6	8	10
	35	2	4	4	6	6	10
	40	2	2	2	4	6	10

Case 5. All units with OPS module installed

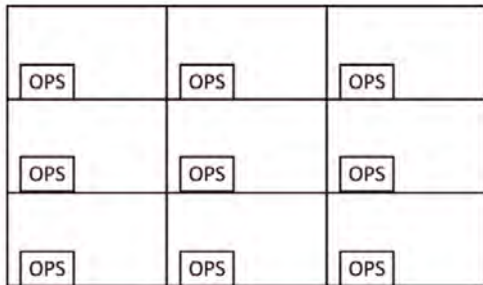

Table of MAX. rows in height

		Wall Mount Clearance					
		5mm (ADA)	1 inch	2 inch	3 inch	4 inch	>5 inch
Operating Temperature (°C)	25	4	5	6	8	10	10
	30	4	4	5	7	9	10
	35	3	4	4	6	7	10
	40	2	3	3	5	6	10

FHD554-XZ-R & FHD554-XZ-HR

Case 1. Without OPS module

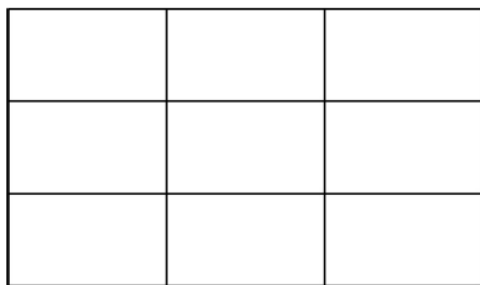

Table of MAX. rows in height

		Wall Mount Clearance					
		5mm (ADA)	1 inch	2 inch	3 inch	4 inch	>5 inch
Operating Temperature (°C)	25	5	6	7	8	10	10
	30	5	6	6	7	10	10
	35	4	5	5	7	9	10
	40	3	4	5	6	8	10

Case 2. With one OPS module installed

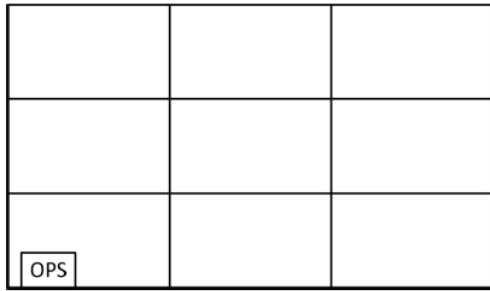

Table of MAX. rows in height

		Wall Mount Clearance					
		5mm (ADA)	1 inch	2 inch	3 inch	4 inch	>5 inch
Operating Temperature (°C)	25	5	6	7	8	10	10
	30	5	6	6	7	10	10
	35	4	5	5	7	9	10
	40	3	4	5	6	8	10

Case 3. With one row OPS modules installed (only the bottom row)

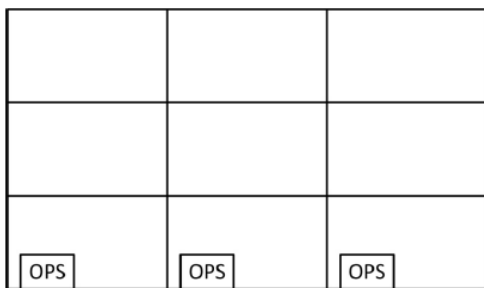

Table of MAX. rows in height

		Wall Mount Clearance					
		5mm (ADA)	1 inch	2 inch	3 inch	4 inch	>5 inch
Operating Temperature (°C)	25	5	6	7	8	10	10
	30	4	5	6	7	10	10
	35	4	5	5	6	8	10
	40	3	4	5	5	7	10

Case 4. With OPS modules installed in every odd row

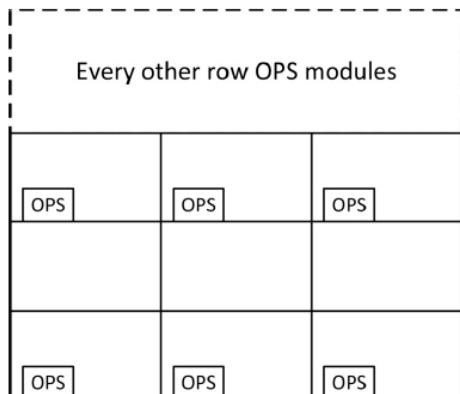

Table of MAX. rows in height

		Wall Mount Clearance					
		5mm (ADA)	1 inch	2 inch	3 inch	4 inch	>5 inch
Operating Temperature (°C)	25	4	4	6	6	8	10
	30	4	4	4	6	8	10
	35	2	4	4	4	6	10
	40	2	2	4	4	6	10

Case 5. All units with OPS module installed

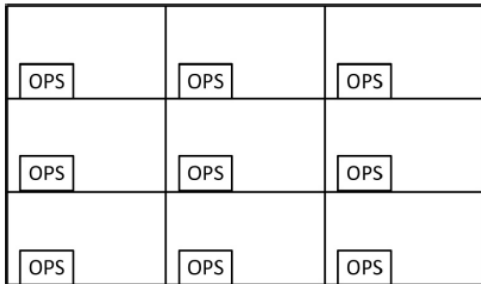

Table of MAX. rows in height

		Wall Mount Clearance					
		5mm (ADA)	1 inch	2 inch	3 inch	4 inch	>5 inch
Operating Temperature (°C)	25	4	5	6	7	9	10
	30	4	5	5	6	8	10
	35	3	4	4	5	7	10
	40	3	3	4	5	6	10

Turning on the display panel

Learn how to turn the power on.

1. Turn on all source components.
2. Connect the power cord to the power receptacle on the side of the display panel.
3. Connect the other end of the power cord to a power source.
4. On the side of the display panel, turn on the main power switch.

When the display panel is in Standby mode, the power indicator turns orange.

5. To turn on the display panel, press the power button on the remote control or the keypad.

It might take a few minutes for the display panel to warm up. Once it is warmed up, an image appears on the screen.

Avoiding image retention

Image retention can occur when static content appears on the display panel for long periods of time.

Image retention is not covered under warranty. To prolong the life of your display panel, follow these recommendations.

- Operate the display panel within its rated ambient environment. Christie recommends an operating temperature of 5 to 40 degrees Celsius (41 to 104 degrees Fahrenheit), with a maximum relative humidity of 75%.
- Avoid static content. Christie recommends displaying moving images whenever possible and using a screen saver with a moving image.
- Turn off the display panel when it is not in use or use the Real Time Clock feature to automatically turn off the display panel at preset times of the day.
- Turn on the IRFM setting.

Configuring the on-screen display

Learn how to configure the on-screen display (OSD).

Changing the position of the on-screen display

Learn how to change the position of the on-screen display.

1. Press MENU on the remote control or keypad.
2. Select OSD Settings > OSD H Position / OSD V Position.
 - OSD H Position—Select the desired level to adjust the horizontal position of the OSD menu.
 - OSD V Position—Select the desired level to adjust the vertical position of the OSD menu.

Setting the on-screen display transparency

Learn how to set the transparency of the on-screen display.

1. Press MENU on the remote control or keypad.
2. Select OSD Settings > Transparency.
3. Use the arrows to adjust the degree of translucence in the menus and message boxes.
Zero (0) means that the menus are opaque.

Changing the on-screen display timeout

Learn how to configure the on-screen display timeout.

1. Press MENU on the remote control or keypad.
2. Select OSD Settings > OSD Timeout.
3. Use the arrows to specify how long the menus remain on-screen after selecting them.
Select from 5, 10, 20, 30 to 60 seconds.

Rotating the on-screen display

Learn how to rotate the on-screen display.

1. Press MENU on the remote control or keypad.
2. Select OSD Settings > OSD Rotation.
3. Use the arrows to change the orientation of the OSD menu to match that of the display.

Changing the on-screen display language

By default, the on-screen display language is English.

You can change the display language to Simplified Chinese, French, German, Italian, Portuguese, Russian, Spanish, Korean, or Japanese.

1. Press MENU on the remote control or keypad.
2. Select OSD Settings > Language.
3. Select a language, and then press Enter.

The change takes effect immediately.

Setting up the system

Learn how to configure the system settings.

Adjusting the edges of the image of the display

Learn how to adjust the image outer edges and stretches the remaining picture to fit the display.

1. Press MENU on the remote control or keypad.
2. Select Setup > Overscan.
3. Use the arrows to adjust the range until it fits the entire display.

Changing the behavior of the power LED

Learn how to change the behavior of the power LED.

1. Press MENU on the remote control or keypad.
2. Select Setup > Power LED.
3. Use the arrows to change the behavior of the status indicator LED during standby mode.
 - On—The LED lights orange to indicate that the display is in standby mode.
 - Off—The LED is always off, regardless of the operational state of the display.

Disabling the OPS Always Powered setting

Learn how to turn off the OPS Always Powered setting.

1. Press MENU on the remote control or keypad.
2. Select Setup > OPS Always Powered > Off.

Changing the date and time

Learn how to configure the on-screen display timeout.

1. Press MENU on the remote control or keypad.
2. Select Setup > Real Time Clock > Current Time.
3. Use the arrows to change date and time.

Scheduling when the display is on

Control when the display panel turns on or turns off and program the backlight and the main input source.

1. Press MENU on the remote control or keypad.
2. Select Setup > Real Time Clock > Timer Mode.
3. Use the arrows to program the display to turn on and off, backlight and main input at specified times of day and days of the week.
 - User Mode—Set power-on, power-off times, backlight and main input for each day of the week independently.
 - Everyday—Set the same power-on and power-off times, backlight and main input for every day of the week.
 - Workdays—Set the same power-on and power-off times, backlight and main input for Monday through Friday.
4. Select Enable for each day the schedule is active.

Enabling CEC setting

Learn how to control of a device and display panels over the HDMI port by using one remote control.

1. Press MENU on the remote control or keypad.
2. Select Setup > CEC > On.

CEC setting can only be activated with HDMI-connected device that supports the CEC standard.

Enabling DisplayPort Multi-Stream Transport (MST)

When you enable DisplayPort MST, display panels in a video wall that are connected using DisplayPort 1.2 are recognized by the control computer as independent display panels instead of a single display.

Before enabling DisplayPort MST, consider the following.

- The Video Wall setting in the Multi-Display Control menu should be set to Off.
 - The graphics adapter and operating system on the control computer must support MST. MST mode requires high-quality cables that are DisplayPort certified.
 - Depending on the graphics adapter, up to 4 display panels can be daisy-chained in MST mode.
 - In MST mode, the recommended resolution setting for each display panel is 1920x1080. The maximum resolution of a 2x2 video wall is 3840x2160 at 60 Hz.
 - If you are using the HDMI or DisplayPort inputs, the maximum resolution of the video wall is 3840 x 2160 at 60 Hz.
1. Press MENU on the remote control or keypad.
 2. Select Setup > DPTX > MST.
 3. Use the arrows to enable MST.

Adjusting the image

Use the controls in the Picture Menu to calibrate each display input to achieve optimum picture quality. For more information of color matching settings, refer to *LCD Panel Color Matching Guide – UHD654-X-HR and Extreme Series (P/N: 020-001663-XX)* on the Christie website.

Changing the aspect ratio

Some aspect ratios are unavailable or not useful with certain types of source material.

The optimal setting depends on a number of factors, such as:

- The aspect ratio of the source material, as broadcast or encoded on the playback medium.
- **The “display type” (16:9 or 4:3) and output resolution settings at the source component.** Most modern DVD/BD players and set-top boxes have such controls.
- **Viewer preference (original aspect ratio with “black bars,” or a full-screen presentation with some distortion or cropping).**

To change the aspect ratio, complete the following.

1. Press MENU on the remote control or keypad.
2. Select Picture > Aspect Ratio.
3. For the picture-in-picture settings, select Picture > PIP > Aspect Ratio.

Use the arrows to select the Full Screen (default), 4:3, Letterbox, or Native aspect ratio.

Changing the image preset

Learn how to change the image preset.

1. Press MENU on the remote control or keypad.
2. Select Picture > Scheme.
3. Select one of four presets (Vivid, Cinema, Game or Sport) depending on the type of program material you are viewing.

These presets automatically adjust the other image settings for optimal image quality.

4. Alternatively, select User to adjust Brightness, Contrast and other settings manually.

Changing the contrast

Learn how to change the contrast controls.

A change to one may require a subtle change to the other in order to achieve the optimum setting.

1. Display a PLUGE (Picture Line-Up Generation Equipment) test pattern.



2. Press MENU on the remote control or keypad.
3. Select Picture > Contrast.
4. Select the desired level to adjust the level of the contrast to a point where the white rectangle starts to increase in size.

Modifying the brightness

Learn how to change the brightness controls.

A change to one may require a subtle change to the other in order to achieve the optimum setting.

1. Display a PLUGE (Picture Line-Up Generation Equipment) test pattern.

PLUGE patterns vary but generally consist of some combination of black, white and gray areas against a black background. The example below includes two vertical bars and four shaded boxes.

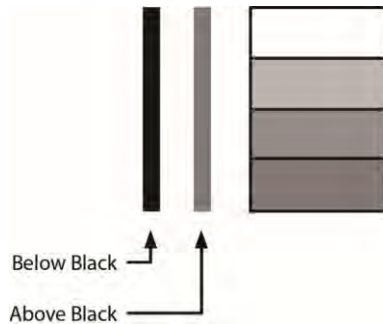

2. Select Picture > Brightness.
3. Select the desired level to adjust the brightness until:
 - The darkest black bars disappear into the background.
 - The dark gray areas are barely visible.
 - The lighter gray areas are clearly visible.
 - The white areas are a comfortable level of true white.
 - The image contains only black, gray and white (no color).

Sharpening the image

Learn how to sharpen the image on a display panel.

1. Select a test pattern similar to the one shown below

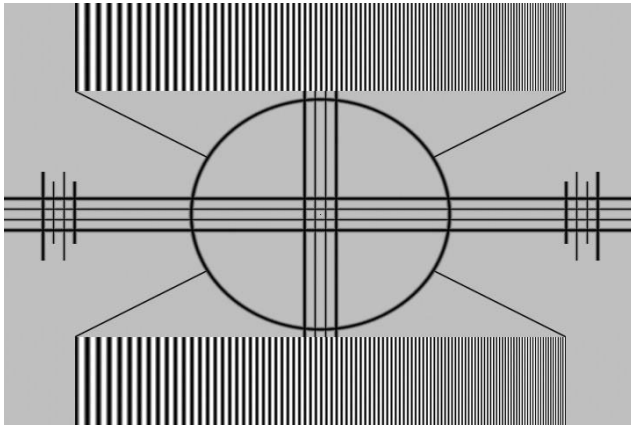

2. Press MENU on the remote control or keypad.
3. Select Picture > Sharpness.
4. Select the desired level to adjust the sharpness.

Look for white edges around the transitions from black to gray and differently-sized lines in the sweep patterns at the top and bottom. Lower the sharpness setting to eliminate them.

Adjusting the hue of the image

The hue (or tint) is the ratio of red to green in the color portion of the image.

When hue is decreased, the image appears red; when it is increased, the image appears green. Saturation and hue are interactive. A change to one may require a subtle change to the other in order to achieve the optimum setting.

1. Press MENU on the remote control or keypad.
2. Select Picture > Hue.
3. Select the desired level to adjust the hue.

Changing the saturation

Saturation and hue are interactive.

A change to one may require a subtle change to the other in order to achieve the optimum setting.

1. Select a color bar test pattern similar to the one shown below and apply a blue filter.

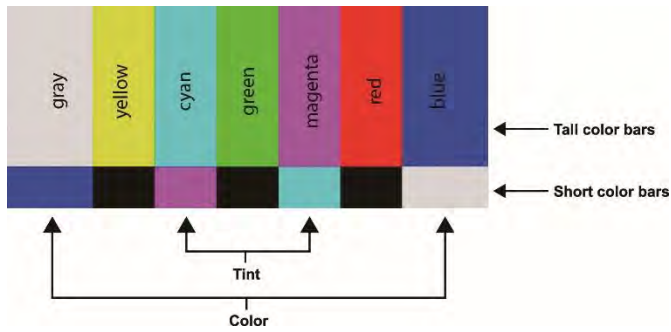

2. Press MENU on the remote control or keypad
3. Select Picture > Saturation.
4. While looking at the color bar pattern through a blue filter, adjust the color saturation level until the outermost (gray and blue) color bars appear to be a single shade of blue.

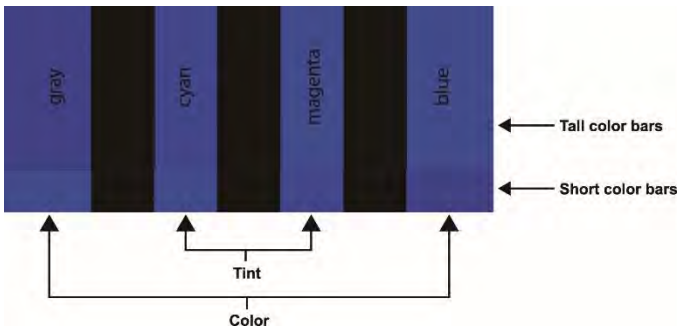

Changing the backlight

Learn how to change the backlight setting on a display panel.

1. Press MENU on the remote control or keypad.
2. Select Picture > Backlight.
3. Select the desired level to adjust the apparent brightness of the image.

Changing the gamma settings

Learn how to change the gamma settings on a display panel.

1. Press MENU on the remote control or keypad.
2. Select Picture > Color Temperature & Gamma > Gamma.
3. Use the arrows to select 2.2 (default) or Off.

When off is selected, Calibration and Color Temperature settings are not available.

Calibrating the image

Learn how to calibrate the image on a display panel.

1. Press MENU on the remote control or keypad.
2. Select Picture > Color Temperature & Gamma > Calibration.
3. Select the display type.
 - Single Display—Use when a single display panel is used by itself, not as part of a video wall. In this mode, the display panel is calibrated to match the selected color temperature very closely.
 - Multi-Display—Use when the display panel is used as part of a video wall. In this mode, the display panel is finely calibrated to match adjacent displays.

When display panels are used as part of a video wall, all display panels in the video wall should have Calibration set to Multi-Display for best panel matching.

Setting the color temperature

Learn how to set the color temperature on a display panel.

1. Press MENU on the remote control or keypad.
2. Select Picture > Color Temperature & Gamma > Temperature.
3. Use the arrows to adjust the overall color temperature, or to adjust the individual gain and offset for red, green, and blue.

Setting the RGB Adjust

Learn how to set the color temperature on a display panel.

1. Press MENU on the remote control or keypad.
2. Select Picture > Color Temperature & Gamma > RGB Adjust.
3. Use the arrows to adjust the overall gain and offset.

Selecting the RGB Range

Learn how to change the range of colors shown on a display panel.

1. Press MENU on the remote control or keypad.
2. Select Picture > RGB Range.
3. Select an appropriate RGB range setting or select auto to let the monitor to detect it automatically.

Updating display settings

Learn how to configure basic and advanced display settings.

Configuring the display settings

Complete these tasks when configuring the display.

Selecting a source

Learn how to select a source.

1. Press MENU on the remote control or keypad.
2. Select Input > Main Input.

Select one source and set as the main input source.

Source options include DisplayPort 1 (default), DisplayPort 2, HDMI1, HDMI2 and OPS. The OPS option is only available if an OPS module is installed in the panel.

Enabling Auto Scan

Auto Scan causes the Main or PIP input select functions (using the SOURCE button on the remote control unit or keypad, or the P-Source button on the remote control unit) to skip over unused inputs, saving time.

1. Press MENU on the remote control or keypad.
2. Select Input > Auto Scan.
3. Use the arrows to select Off, Main, Multi or All.

Enabling Multi-Source Views

Learn how to select a source.

1. Press MENU on the remote control or keypad.
2. Select Input > Multi-Source Views.
3. Use the arrows to select Off (default), Dual View, PIP or Quad view.

Enabling picture-in-picture mode

Learn how to turn on picture-in-picture mode.

4. Press MENU on the remote control or keypad.
5. Select Input > Multi-Source Views > PIP.
6. Use the arrows to enable picture-in-picture (PIP) mode.

To swap the main and PIP images, press SWAP on the remote control.

Selecting picture-in-picture source

Learn how to select a PIP signal source.

1. Press MENU on the remote control or keypad.
2. Select I nput.
3. Ensure PIP is enabled.
4. Select Source 2 and use the arrow keys to select an input source.

Setting the picture-in-picture size

Learn how to set the picture-in-picture size.

1. Press MENU on the remote control or keypad.
2. Select I nput.
3. Ensure PIP is enabled.
4. Select PIP Size and use the arrows to select the size of the Picture-in-Picture window.
PIP size options include: Small, Mid and Large.

Setting the picture-in-picture position

Learn how to set the picture-in-picture position.

1. Press MENU on the remote control or keypad.
2. Select I nput.
3. Ensure PIP is enabled.
4. Select PIP Position and use the arrows to select the position of the Picture-in-Picture window.
PIP position options include: Bottom Right, Top Left, Top Right or Bottom Left.

Setting Input Swap

Learn how to swap the main and PIP images

1. Press MENU on the remote control or keypad.
2. Select I nput > I nput Swap.

Configuring advanced settings

Learn how to configure advanced settings on a display panel.

Enabling IRFM

The Image Retention Frame Motion (IRFM) setting creates slight frame motion to help avoid image retention.

1. Press MENU on the remote control or keypad.
2. Select Adv. Setup > I RFM.
3. Use the arrows to enable this feature.

Turning off local dimming

By default, local dimming is set to On.

Local dimming automatically adjusts areas of the LCD backlight to create deeper black levels and higher contrast. To avoid an overly dark image when displaying content that includes fine details on a black background, turn this feature off.

1. Press MENU on the remote control or keypad.
2. Select Adv. Setup > Local Dimming.
3. Select Off.

Choosing Power Saving mode

Choose when a display panel wakes up from power-saving mode.

1. Press MENU on the remote control or keypad.
2. Select Adv. Setup > Power Saving.
3. Use the arrow keys to select one of the following.
 - Eco—The display panel **don't wake up from sleep mode even when it receives an active video signal from its input and can't be waked up by RS232 command**
 - Normal—The display wakes up when it receives an active signal from its inputs and can be waked up by RS232 command as well.
 - Never Sleep—The display panel never enters power-saving mode.

Adjusting Edge Enhancement

Enhance and sharpening the edge contrast of large images or pictures.

1. Press MENU on the remote control or keypad.
2. Select Adv. Setup > Edge Enhancement.
3. Use the arrows to select any of the following controls.

Edge enhancement options include: Off, Low, Medium and High.

Selecting DisplayPort version

Choose DisplayPort's version of the DP1 & DP2 inputs.

4. Press MENU on the remote control or keypad.
5. Select Adv. Setup > DP1 Ver. or DP2 Ver.
6. Use the arrows to select version 1.1 or 1.2.

Configuring EDID settings

Select EDID (Extended Display Identification Data) of the HDMI and DisplayPort inputs

1. Press MENU on the remote control or keypad.

2. Select Adv. Setup > EDID Setup.
3. Use the arrows to select the option for inputs.

Updating Multi-Display Control settings

Use the Multi-Display Control to display content from a single video source over an entire video wall.

The content is automatically scaled and cropped in each display panel to create a single large virtual display spanning the full video wall. The Multi-Display Control also allows you to control other features, such as the removal of the geometric effect of the LCD bezels.

Before using the Multi-Display Control, consider that when you use the Multi-Display Control, the identical video signal must be distributed to each display panel in a video wall. To do this, daisy-chain the display panels together using the video input and output connectors or use an external video splitter.

1. Press MENU on the remote control or keypad.
2. Select Adv. Setup > Multi-Display Control.
3. Use the arrow keys to select any of the following controls.
 - Monitor ID—Manually set the Monitor ID of each display panel in a video wall.
 - Video Wall—Enable or disable Video Wall mode. When enabled, each display panel in a video wall attempts to match its luminance settings with the adjacent panels it is connected to.
 - Power On Delay—Stagger the Power-On sequence so that monitors do not turn on at once, reducing current requirements. Select a value from 0 to 30 seconds for each monitor.
 - Video Delay—Removes tearing artifacts in fast motion video for video walls of maximum 3 rows by adjusting the video frame delay on every other row. Select an option: Off, Auto, 1 Frame, 0.5 Frame.

Updating Multi-Display Control settings for a video wall

If you enable the Video Wall setting from the Multi-Display Control settings menu, additional settings are available.

1. Press MENU on the remote control or keypad.
2. Select Adv. Setup > Multi-Display Control > Video Wall.
3. Use the arrows to select Yes to enable the Video Wall.
4. Update any of the following settings.
 - Frame—Enables or disables frame compensation to join the edges of adjacent display panels in a video wall together. This can compensate for the gap between the display panels.
When enabled, moving objects in a video move behind the gap. This allows for better continuity of motion across the video wall and is suitable for moving images. When disabled, joints between the display panels are shown. This is suitable for still images.
 - Matrix X—Specifies the number of columns in a video wall.
 - Matrix Y—Specifies the number of rows in a video wall.
 - Division X—Specifies the horizontal position (column) of a display panel in a video wall.
 - Division Y—Specifies the vertical position (row) of a display panel in a video wall.

- IR Mode—If the remote control should control all display panels in a video wall, select All. If the remote control should control one display panel at a time, select Target. To use this option, RS485 cables must be connected to the display panel. **Press and hold the IR “Menu” button for 3 seconds**, the setting will go back to the initial value: IR Mode = Off, Recipient ID = 1
- Recipient ID—Selects which display panel is controlled by the remote control. To use this feature, set the IR Mode to Target. RS485 cables must be connected to the display panel.
- Auto Video Wall Setup—Automatically sets the monitor IDs for all display panels in a video wall. To use this option, RS485 cables must be connected to the display panel.

Obtaining the temperature and fan status

Learn how to obtain information about the health of a display panel such as the internal operating temperature, the cooling fan speed, or the highest temperature reached.

1. Press MENU on the remote control or keypad.
2. Select Adv. Setup > Temperature & Fan Status.

Performing a factory reset

Learn how to restore all display settings, including image settings, to their factory defaults. This action is not reversible.

1. Press MENU on the remote control or keypad.
2. Select Adv. Setup > Factory Reset.
3. Select Yes to restore the factory default settings.

Configuring communications settings

Learn how to configure RS232 and Ethernet communication settings on a display panel.

Setting the baud rate

The baud rate sets the data rate of the RS232 communication link.

1. Press MENU on the remote control or keypad.
2. Select Communication > Baud Rate.
3. Use the arrows to select a baud rate.

Configuring Ethernet settings

Learn how to configure network settings.

1. Press MENU on the remote control or keypad.
2. Select Communication > IP Address Settings.
3. Use the arrows to update any of the following.
 - Dynamic IP—Select Enable to enable DHCP for dynamic IP address assignment.

- IP Address—Sets the static IP address when the Dynamic IP is disabled or views the static IP address when the Dynamic IP is enabled.
Range: 255.255.255.255 (0.0.0.0).
- Subnet Mask—Sets the subnet mask when the Dynamic IP is disabled or views the subnet mask when the Dynamic IP is enabled.
Range: 255.255.255.255 (0.0.0.0).
- Gateway—Sets the gateway when the Dynamic IP is disabled or views the gateway when the Dynamic IP is enabled.
Range: 255.255.255.255 (0.0.0.0).
- DNS Address—Sets the DNS address when the Dynamic IP is disabled or views the DNS address when the Dynamic IP is enabled.
Range: 255.255.255.255 (0.0.0.0).
- Save Settings—If the Dynamic IP is disabled, select Yes to save the network configuration.
- Refresh—Refreshes the configuration of the Static IP Address, Subnet Mask, Gateway, and DNS Address.

Enabling email alerts

Enable or disable any of the following email alerts.

Enabling power status alert

Learn how to send an alert if a display panel is turned on or off.

1. Press MENU on the remote control or keypad.
2. Select Communication > Power Status Alert > On.

Enabling source status alert

Learn how to send an alert if a different source is selected.

1. Press MENU on the remote control or keypad.
2. Select Communication > Source Status Alert > On.

Enabling signal lost alert

Learn how to send an alert if the input signal is lost.

1. Press MENU on the remote control or keypad.
2. Select Communication > Signal Lost Alert > On.

Loading the network settings

Learn how to load default network settings.,

1. Press MENU on the remote control or keypad.
2. Select Communication > Load Default > Yes.

Configure SNMP settings

Learn how to configure the Simple Network Management Protocol (SNMP) settings

1. Press MENU on the remote control or keypad.
2. Select Communication > SNMP.
3. Update any of the following settings.
 - Trap—Enable sending alerts if detects power, source or signal is changed
 - Power Changed Alarm—Send an alert if a different power is changed.
 - Source Changed Alarm—Send an alert if a different source is changed.
 - Signal Changed Alarm—Send an alert if a different signal is changed.
 - Trap IP—The Trap IP is read-only and provides the Trap IP address information about the PC.
 - Trap UDP—The Trap UDP is read-only and provides the Trap UDP address information about the PC.

Reading the IP address

Shows the IP address on the main menu of the display panel.

1. Press MENU on the remote control or keypad.
2. Select Communication > IP Address.

The IP Address menu is read-only and provides the IP address information about the display panel.

Reading the device MAC address

Shows the unique address assigned to network interfaces.

1. Press MENU on the remote control or keypad.
2. Select Communication > Device MAC.

The Device MAC menu is read-only and provides the MAC address information about the display panel.

Reading the system information

You can find the system information on the main menu of the display panel.

1. Press MENU on the remote control or keypad.
2. Select I nformation.

The Information menu is read-only and provides the following information about the display panel.

- The name of the main input source.
- The number of hours the display has been in operation.
- The current firmware version.
- The serial number of the display.

Recommended low-light image settings

If a display panel is set up in an area with low ambient light levels, such as a broadcast studio or a museum, the display panel should be set to a low luminance to blend in with the environment or to match the color temperature of studio lighting. To attain the highest quality image, Christie recommends the following image settings for low-light environments.

Image setting	Recommended range
Backlight	25% or higher
Contrast	40% or higher
Color Temperature	5000K or higher

Troubleshooting

Learn about common issues and their solutions.

The Extreme Series display panels does not require any routine maintenance. There are no user-serviceable or replaceable parts. Do not attempt to repair or replace any system component yourself unless you are a qualified, factory trained-technician, as doing so voids the product warranty.

The display does not turn on

No video is displayed on the panel.

Details

Possible causes for this issue include:

- The display is not plugged in or the power outlet is not active.
- The main power switch is off.
- The remote control batteries have run out.

Resolution

Possible causes for this issue include:

- Ensure that the display is plugged in and that the power outlet is active.
- Set the main power switch to the on position.
- Replace the batteries.

The remote control does not work

Pressing buttons on the remote control does not affect the display.

Details

Possible causes for this issue include:

- The remote control batteries have run out.
- The buttons are locked.
- IR extender is not connected.

Resolution

- Replace the batteries.
- Unlock the buttons by pressing ENTER, ENTER, EXIT, EXIT, ENTER and EXIT, in sequence.
- Verify that the IR extender cable is correctly connected.

The image geometry is incorrect

The image is displayed with an incorrect aspect ratio.

Resolution

Select a different aspect ratio.

The content is jittery or unstable

The content on the display panel is poor-quality or the panel is improperly connected to the source.

In some cases, the horizontal or vertical scan frequency of the input signal may be out of range for the display panel.

Resolution

- Verify that the source is properly connected.
- Correct the quality of the content.

The image is too bright or lacks definition

The image contrast is set too high and the bright areas of the image have no definition.

Resolution

Decrease the contrast setting.

The image appears washed out

The dark areas of the displayed image are too bright.

Resolution

Decrease the brightness settings.

The image is too dark

The image appears too dark when the brightness or backlight are set too low.

Resolution

Increase the brightness or backlight settings.

Images from the HDMI source do not display

Source video over HDMI does not display on the panel.

Details

Possible causes for this issue include:

- The resolution and frequency of the video card in the computer are not compatible with the display.
- HDMI cable from source to display is either defective or too long.

Resolution

- Select a compatible resolution and vertical frequency.

- Try a known-good and/or shorter HDMI cable.

Computer images do not display correctly

Images that originate from a computer source do not display correctly on the panel.

Details

Possible causes for this issue include:

- The resolution and frequency of the video card in the computer are not compatible with the display.
- Clock and Phase settings need adjustment.

Resolution

- Select a compatible resolution and vertical frequency.
- Adjust Clock and Phase settings.

Specifications

Learn about the product specifications. Due to continuing research, specifications are subject to change without notice.

Physical specifications

Learn the physical specifications for the FHD554-XZ, FHD554-XZ-R, FHD554-XZ-H and the FHD554-XZ-HR panels.

Model	FHD554-XZ	FHD554-XZ-R	FHD554-XZ-H	FHD554-XZ-HR
Descriptions				
Dimensions (W x H x D)	1210.5 mm x 681.2 mm x 95.3 mm (without handle)			
Weight	Net: 28 kg (w/o stand) / 61.7 lbs; Gross: 38.5 kg / 84.9 lbs			
Wall Mount	400 mm x 400 mm VESA			
Bezel Width	0.44 mm (Top/Left/Bottom/Right)			
Brightness	500 cd/m ²		700 cd/m ²	
Contrast Ratio	1100: 1			
Viewing Angle	H: 178° / V: 178°			
Response Time	8 ms			
Supported Colors	1.07 million colors			
Display Resolution	1920 x 1080 (16:9)			
Display Frame Rate	60 Hz			
Rotation	Landscape / Portrait			
Control	RS232C, Ethernet, built-in keypad, IR remote control			
OSD Language	English, Simplified Chinese, French, German, Italian, Portuguese, Russian, Spanish, Korean, Japanese			
Picture Options	PIP, PBP (Side-by-Side)			
Source Auto Detect	Yes			
Key Lock	Yes			
Horizontal / Vertical Frequency	27 ~ 135 KHz / 23 ~ 85 Hz			
Input Resolution	1920 x 1080 @ 60 Hz (Digital)			
Connectors	DisplayPort (In / Out) / HDMI x 2 / IR Receiver / Ethernet / OPS Slot / SPDIF Out			
Communication Ports	RS232C In, RS485 In/Out			

Remote Power Rack Shelf (for FHD554-XZ-R & FHD554-XZ-HR)

Descriptions	Details
Dimensions (W x H x D)	485 mm x 133 mm x 395 mm (19.09 in x 5.24 in x 15.55 in)
Weight	Shelf: 11.5 kg (30.8 lbs) Rectifiers: 2.5 kg (6.7 lbs) per unit, four units maximum

Power requirements

Learn the power requirements for the Extreme Series panels, and the Remote Power Rack Shelf.

Input ratings and power consumption for LCD panels

Power consumption specifications do not include the power consumption of a control computer or a device connected to the OPS module of the display panel.

Descriptions	FHD554-XZ & FHD554-XZ-H	FHD554-XZ-R & FHD554-XZ-HR
Power Supply	AC 100-240V (50-60Hz), 4.2A, max	58 VDC max
Power Consumption	205W (normal), 280W (maximum)	205W (normal), 265W (maximum)

Power ratings for the Remote Power Rack Shelf (for FHD554-XZ-R & FHD554-XZ-HR)

Descriptions	Details
Input voltage	120-230 VAC, 50/60 Hz 12A at 120VAC - 9.5A @ 230 VAC per rectifier (maximum four rectifiers installed)
Output	42-58 VDC, 48V nominal, 30A per output (with maximum four rectifiers installed)

The number of displays that can be powered by a single Remote Power Rack Shelf depends on the voltage range of the input and the number of rectifiers. In certain situations, this can be up to 24 LCD panels per Remote Power Rack Shelf. Please consult your local Christie representative for further details.

	PSU modules	Max power AC input: 187-312 V	De-rated power AC input: 120 V	AC input: 176 V
Total output power (no redundancy)	1	2000W	1200W	1800W
	2	4000W	2400W	3600W
	3	5760W	3600W	5400W
	4	5760W	4800W	5760W

	PSU modules	Max power AC input: 187-312 V	De-rated power AC input: 120 V	AC input: 176 V
Total output power (n+1 redundancy)	2	2000W	1200W	1800W
	3	4000W	2400W	3600W
	4	5760W	3600W	5400W

Environmental specifications

Learn the environmental specifications for the Extreme Series panels.

FHD554-XZ, FHD554-XZ-R, FHD554-XZ-H and FHD554-XZ-HR

Descriptions	Details
Operating Temperature	0°C ~ 40°C, 90% RH
Storage Temperature	-20°C ~ 60°C, 90% RH
Heat output	FHD554-XZ-H, FHD554-XZ-H — 699 BTU/hr (typical), 955 BTU/hr (maximum, non-OPS) FHD554-XZ-R, FHD554-XZ-HR — 699 BTU/hr (typical), 904 BTU/hr (maximum, non-OPS)

Remote Power Rack Shelf (for FHD554-XZ-R & FHD554-XZ-HR)

Descriptions	Details
Temperature	Operating: -10 to 35°C (14°F to 95°F) Storage: -40 to 85°C (-40 to 185°F)
Humidity (non-condensing)	Operating: 0% to 93% Non-operating: 0% to 95%
Elevation	-60 to 2000 m (-198 to 6600 ft)
Heat dissipation	<2196 BTU per hour (four PSU modules)
Acoustic	Max 66dB (four PSU modules)

Supported timings

Learn the supported timings for the Extreme Series panels.

X : Support 8/10 bpc color depth. Δ: Support 8 bpc color depth.

Compatible Video Sources									
Signal Type	Resolution	Frame Rate (Hz)	Line Rate (kHz)	Pixel Rate (MHz)	OPS	HDMI 1-2	DP1-2	DPTX	References
PC	640x480	59.940	31.469	25.175	x	x	x		VESA DMT, CEA-861-F Format 1
	640x480	72.809	37.861	31.500	x	x	x		VESA DMT
	640x480	75.000	37.500	31.500	x	x	x		VESA DMT
	640x480	85.008	43.269	36.000	x	x	x		VESA DMT
	800x600	60.317	37.879	40.000	x	x	x		VESA DMT
	800x600	72.188	48.077	50.000	x	x	x		VESA DMT
	800x600	75.000	46.875	49.500	x	x	x		VESA DMT
	800x600	85.061	53.674	56.250	x	x	x		VESA DMT
	848x480	59.659	29.830	31.500	x	x	x		VESA CVT
	848x480	74.769	37.684	41.000	x	x	x		VESA CVT
	848x480	84.751	42.969	46.750	x	x	x		VESA CVT
	1024x768	60.004	48.363	65.000	x	x	x		VESA DMT
	1024x768	70.069	56.476	75.000	x	x	x		VESA DMT
	1024x768	75.029	60.023	78.750	x	x	x		VESA DMT
	1024x768	84.997	68.677	94.500	x	x	x		VESA DMT
	1152x864	70.012	63.851	94.500	x	x	x		VESA DMT
	1152x864	75.000	67.500	108.000	x	x	x		VESA DMT
	1152x864	84.999	77.094	121.500	x	x	x		VESA DMT
	1280x768	49.929	39.593	65.250	x	x	x		VESA CVT
	1280x768	59.995	47.396	68.250	x	x	x	x	VESA CVT-R
	1280x768	59.870	47.776	79.500	x	x	x	x	VESA CVT
	1280x768	74.893	60.289	102.250	x	x	x		VESA CVT
	1280x768	84.837	68.633	117.500	x	x	x		VESA CVT
	1280x960	60.000	60.000	108.000	x	x	x		VESA DMT
	1280x960	75	75.000	126.000	x	x	x		VESA DMT
	1280x960	85.002	85.938	148.500	x	x	x		VESA DMT
	1280x1024	60.020	63.981	108.000	x	x	x	x	VESA DMT
	1280x1024	75.025	79.976	135.000	x	x	x		VESA DMT
1280x1024	85.024	91.146	157.500	x	x	x		VESA DMT	

Compatible Video Sources									
Signal Type	Resolution	Frame Rate (Hz)	Line Rate (kHz)	Pixel Rate (MHz)	OPS	HDMI 1-2	DP1-2	DPTX	References
PC	1366x768	59.790	47.712	85.500	x	x	x	x	VESA DMT
	1400x1050	49.965	54.113	100.000	x	x	x		VESA CVT
	1400x1050	59.948	64.744	101.000	x	x	x		VESA CVT-R
	1400x1050	59.978	65.317	121.750	x	x	x		VESA CVT
	1400x1050	74.867	82.278	156.000	x	x	x		VESA CVT
	1600x1200	60.000	75.000	162.000	x	x	x	x	VESA DMT
	1920x1080	49.929	55.621	141.500	x	x	x		VESA CVT
	1920x1080	59.963	67.158	173.000	x	x	x		VESA CVT
	1920x1080	59.950	66.587	138.500	x	x	x	x	VESA CVT-R
	1920x1200	49.932	61.816	158.250	x	x	x		VESA CVT
	1920x1200	59.950	74.038	154.000	x	x	x	x	VESA CVT-R
	1680x1050	49.974	54.121	119.500	x	x	x		VESA CVT
	1680x1050	59.954	65.290	146.250	x	x	x	x	VESA CVT
	1920x2160	60.000	135.000	297.000	x	x	x	Δ	CEA-861-F, VIC 16, with vertical parameters doubled
	1920x2160	59.988	133.293	277.250	x	x	x	Δ	VESA CVT-R
	2560x1440	59.951	88.787	241.500	x	x	x	Δ	VESA CVT-R
	2560x1600	59.972	98.713	268.500	x	x	x		VESA CVT-R
	3840x2160	23.999	52.438	209.750	x	x	x		VESA CVT-R
	3840x2160	29.981	65.688	262.750	x	x	x		VESA CVT-R
	3840x2160	49.977	110.500	442.000	x	x	x		VESA CVT-R
3840x2160	59.997	133.313	533.250	x	x	x	Δ	VESA CVT-R	
Apple Mac	640x480	66.59			x	x	x		
	832x624	75.087	49.107	55.000	x	x	x		
	1024x768	59.278	48.193	64.000	x	x	x		
	1024x768	74.927	60.241	80.000	x	x	x		
	1152x870	75.062	68.681	100.000	x	x	x		

Compatible Video Sources									
Signal Type	Resolution	Frame Rate (Hz)	Line Rate (kHz)	Pixel Rate (MHz)	OPS	HDMI 1-2	DP1-2	DPTX	References
SDTV	480i	60			x	x			SMPTE 125M, CEA-861-F Formats 6 & 7
	576i	50			x	x			ITU-R BT.601, CEA-861-F Formats 21 & 22
EDTV	480p	60	31.469	27.000	x	x	x		ITU-R BT.1358, CEA-861-F Format 17 & 18
	576p	50	31.250	27.000	x	x	x		SMPTE 125M, CEA-861-F Format 6 & 7
HDTV	1080i	50	28.125	74.500	x	x	x		SMPTE 274M, CEA-861-F Format 20
	1080i	60	33.750	74.250	x	x	x		SMPTE 274M, CEA-861-F Format 5
	720p	50	37.500	74.250	x	x	x		SMPTE 296M, CEA-861-F Format 19
	720p	60	45.000	74.250	x	x	x	x	SMPTE 296M, CEA-861-F Format 4
	1080p	24	27.000	74.250	x	x	x	x	SMPTE 274M, CEA-861-F Format 32
	1080p	25	28.125	74.250	x	x	x	x	SMPTE 274M, CEA-861-F Format 33
	1080p	30	33.750	74.250	x	x	x	x	SMPTE 274M, CEA-861-F Format 34
	1080p	50	56.250	148.500	x	x	x	x	SMPTE 274M, CEA-861-F Format 31
UHDTV	1080p	60	67.500	148.500	x	x	x	x	SMPTE 274M, CEA-861-F Format 16
	3840x2160	24	54.000	297.000	x	x	x	x	CEA-861-F Format 93, HDMI 1.4b VIC 1
	3840x2160	25	56.250	297.000	x	x	x	x	CEA-861-F Format 94, HDMI 1.4b VIC 2
	3840x2160	30	67.500	297.000	x	x	x	x	CEA-861-F Format 95, HDMI 1.4b VIC 3
	3840x2160	50	67.500	297.000	x	x			CEA-861-F Format 96, 4:2:0 sub-sampling
	3840x2160	50	135.000	594.000	x	x	x	Δ	CEA-861-F Format 96
	3840x2160	60	67.500	297.000	x	x			CEA-861-F Format 97, 4:2:0 sub-sampling
	3840x2160	60	135.000	594.000	x	x	x	Δ	CEA-861-F Format 97
	4096x2160	24	54.000	297.000	x	x	x	x	CEA-861-F Format 98
	4096x2160	25	56.250	297.000	x	x	x	x	CEA-861-F Format 99
4096x2160	30	67.500	297.000	x	x	x	x	CEA-861-F Format 100	

Overall dimensions

All dimensions are in millimeters.

FHD554-XZ & FHD554-XZ-H

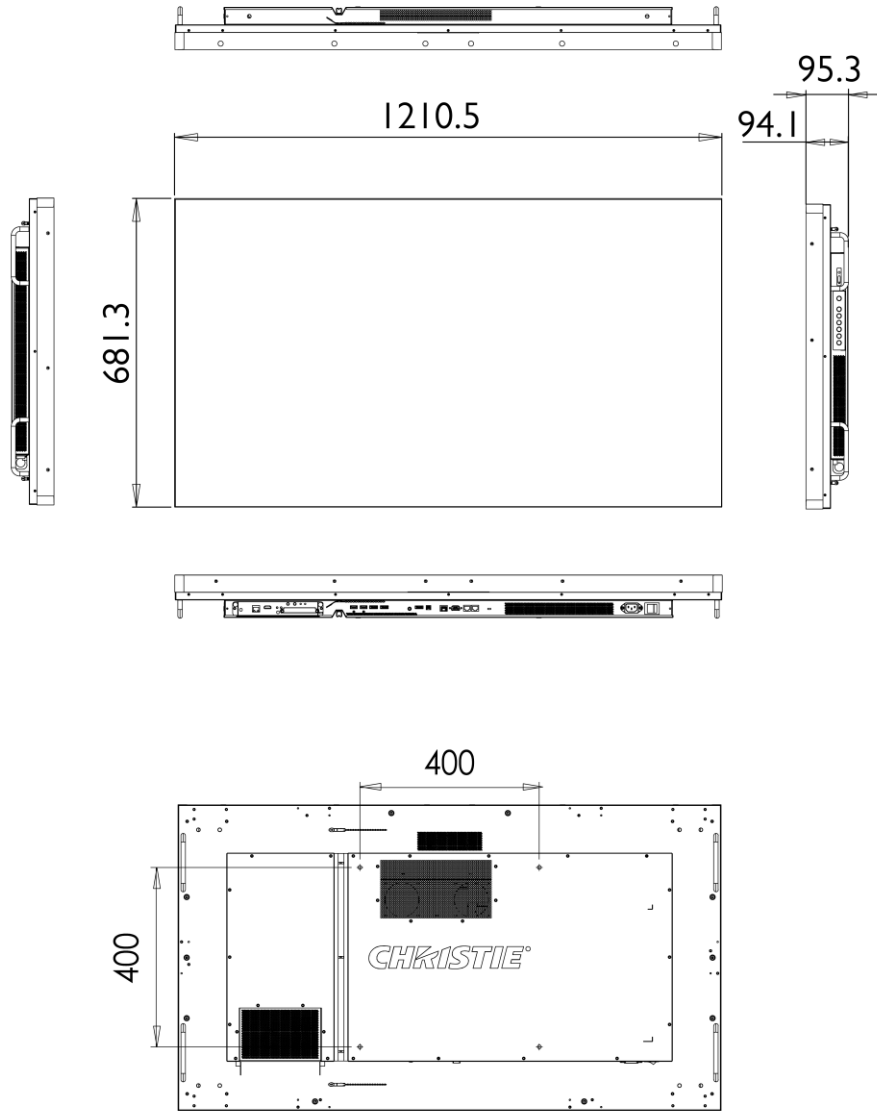

FHD554-XZ-R & FHD554-XZ-HR

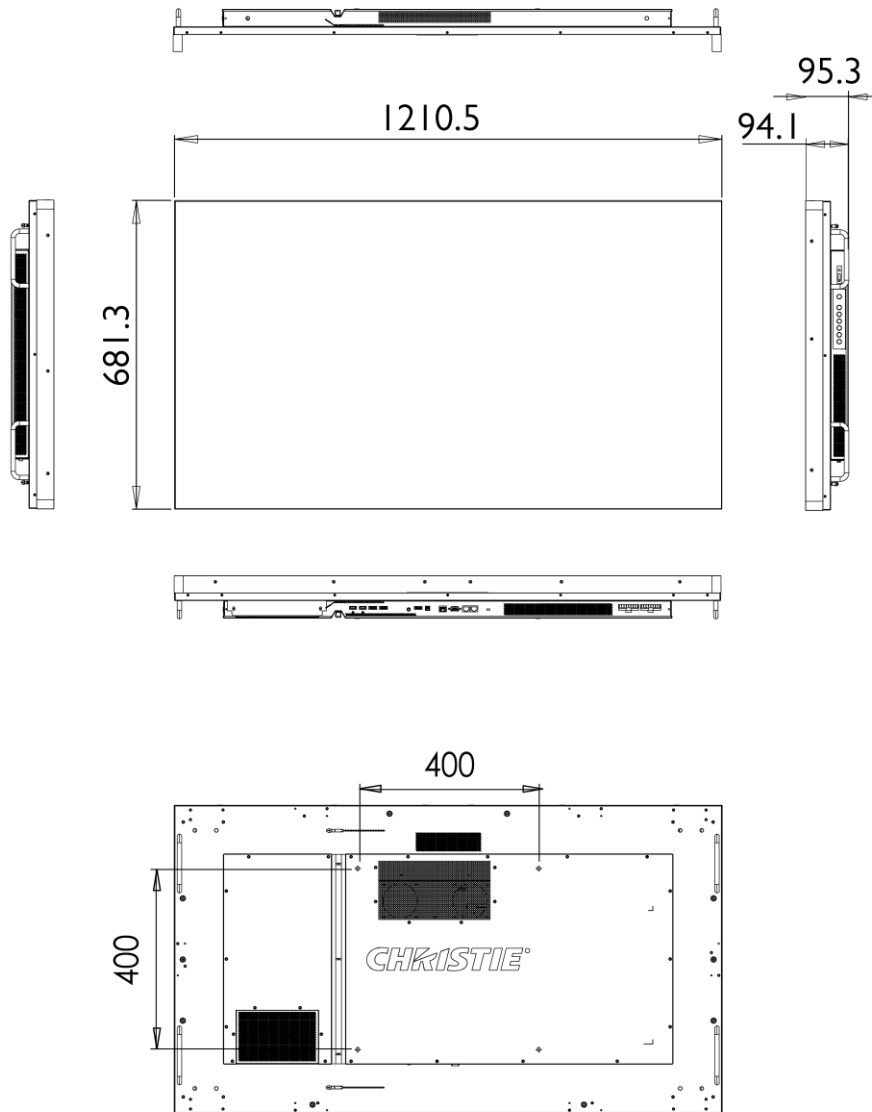

Regulatory

This product conforms to the latest regulations and standards related to product safety, environmental, and electromagnetic compatibility (EMC) requirements.

Safety

- CAN/CSA C22.2 No. 60950-1
- ANSI/UL 60950-1 – Information Technology Equipment – Safety – Part 1: General Requirements
- EN 60950-1 – Information Technology Equipment – Safety – Part 1: General Requirements
- IEC 62368-1 – Audio/video, information and communication technology equipment - Part 1: Safety requirements

Electro-magnetic compatibility

Emissions

- FCC CFR47, Part 15, Subpart B, Class A – Unintentional Radiators
- CAN ICES-3 (A) / NMB-3 (A)
- CISPR 32/EN 55032, Class A

Immunity

- CISPR 24/EN 55024
- IEC 61000-4-2/EN61000-4-2
- IEC 61000-4-3/EN61000-4-3
- IEC 61000-4-4/EN61000-4-4
- IEC 61000-4-5/EN61000-4-5
- IEC 61000-4-6/EN61000-4-6
- IEC 61000-4-8/EN61000-4-8

Environmental

- EU Directive (2011/65/EU) on the restriction of the uses of certain hazardous substances (RoHS) in electrical and electronic equipment and the applicable official amendment(s).
- EU Regulation (EC) No. 1907/2006 on the registration, evaluation, authorization and restriction of chemicals (REACH) and the applicable official amendment(s).
- EU Directive (2012/19/EU) on waste and electrical and electronic equipment (WEEE) and the applicable official amendment(s).
- China Ministry of Information Industry (along with 7 other Government Agencies) Order No.32 (01/2016) on the control of pollution caused by electronic information products, hazardous substances concentration limits (GB/T 26572 - 2011), and the applicable product marking requirement (SJ/T 11364 - 2014).

Corporate offices

Christie Digital Systems USA, Inc.
ph: 714 236 8610

Christie Digital Systems Canada Inc.
ph: 519 744 8005

Worldwide offices

Africa
ph: +27 (0)11 510 0094

Australia
ph: +61 (0) 7 3624 4888

Brazil
ph: +55 (11) 2548 4753

China (Beijing)
ph: +86 10 6561 0240

China (Shanghai)
ph: +86 21 6030 0500

Columbia
ph: +57 (318) 447 3179

France
ph: +33 (0) 1 41 21 44 04

Germany
ph: +49 (0) 221 99512 0

India
ph: +91 (080) 6708 9999

Japan (Tokyo)
ph: 81 3 3599 7481

Korea (Seoul)
ph: +82 2 702 1601

Mexico
ph: +52 55 4744 1790

Singapore
ph: +65 6877 8737

Spain
ph: +34 91 633 9990

Middle East
ph: +971 (0) 503 6800

United Kingdom
ph: +44 (0) 118 977 8000

United States (Arizona)
ph: 602 943 5700

Independant sales consultant offices

Italy
ph: +39 (0) 2 9902 1161

Russia
ph: +36 (0) 1 47 48 100



For the most current technical documentation, visit www.christiedigital.com.

