



User Manual

020-002027-04

Remote Power Rack Shelf

CHRISTIE

NOTICES

COPYRIGHT AND TRADEMARKS

Copyright © 2023 Christie Digital Systems USA, Inc. All rights reserved.

All brand names and product names are trademarks, registered trademarks or trade names of their respective holders.

GENERAL

Every effort has been made to ensure accuracy, however in some cases changes in the products or availability could occur which may not be reflected in this document. Christie reserves the right to make changes to specifications at any time without notice. Performance specifications are typical, but may vary depending on conditions beyond Christie's control such as maintenance of the product in proper working conditions. Performance specifications are based on information available at the time of printing. Christie makes no warranty of any kind with regard to this material, including, but not limited to, implied warranties of fitness for a particular purpose. Christie will not be liable for errors contained herein or for incidental or consequential damages in connection with the performance or use of this material. Canadian manufacturing facility is ISO 9001 and 14001 certified.

For the most current technical documentation and office contact information, visit www.christiedigital.com.

WARRANTY

Products are warranted under Christie's standard limited warranty, the details of which are available at <https://www.christiedigital.com/help-center/warranties/> or by contacting your Christie dealer or Christie.

PREVENTATIVE MAINTENANCE

Preventative maintenance is an important part of the continued and proper operation of your product. Failure to perform maintenance as required, and in accordance with the maintenance schedule specified by Christie, will void the warranty.

REGULATORY (if applicable)

The product has been tested and found to comply with the limits for a Class A digital device, pursuant to Part 15 of the FCC Rules. These limits are designed to provide reasonable protection against harmful interference when the product is operated in a commercial environment. The product generates, uses, and can radiate radio frequency energy and, if not installed and used in accordance with the instruction manual, may cause harmful interference to radio communications. Operation of the product in a residential area is likely to cause harmful interference in which case the user will be required to correct the interference at the user's own expense. Changes or modifications not expressly approved by the party responsible for compliance could void the user's authority to operate the equipment.

CAN ICES-3 (A) / NMB-3 (A)

이 기기는 업무용(A급)으로 전자파적합등록을 한 기기이오니 판매자 또는 사용자는 이점을 주의하시기 바라며, 가정 외의 지역에서 사용하는 것을 목적으로 합니다.

ENVIRONMENTAL



The product is designed and manufactured with high-quality materials and components that can be recycled and reused. This symbol  means that electrical and electronic equipment, at their end-of-life, should be disposed of separately from regular waste. Please dispose of the product appropriately and according to local regulations. In the European Union, there are separate collection systems for used electrical and electronic products.

If printing this document, consider printing only the pages you need and select the double-sided option.

Please help us to conserve the environment we live in!

Content

- Introduction 5**
 - General safety precautions..... 5
 - Electrical safety 6
 - Grounding requirements..... 6
 - Operational requirements..... 6
 - ESD requirements 6
 - Liquid prevention requirements..... 6
 - Mechanical safety..... 7
 - Hoisting devices 7
 - Using a ladder..... 7
 - Moving heavy objects 8
 - Product overview..... 8
 - System features 8
 - Product operation workflow..... 8
 - Configurations..... 9
 - Components..... 9
 - Interior structure..... 10
 - Power distribution 10
 - Rectifier 11
 - Controller 11
- Technical specifications 14**
 - Environmental specifications 14
 - Electrical specifications..... 14
 - Mechanics specifications..... 16
- System installation 18**
 - Installation requirements..... 18
 - Required tools 18
 - Rack mounting safety instruction..... 18
 - Cable routing requirements..... 19
 - Installing the sub-rack 19
 - Unpacking and acceptance 19
 - Installing the sub-rack 20
 - Installing the ground cable..... 20

Installing the rectifier	21
Installing the communication cables.....	21
Network setup using a wired router	21
Network router configuration	21
Network setup using a separate network.....	23
Installing the DC cable	24
Installing the AC cable.....	25
Inspecting the installation.....	26
System check.....	27
Power on commissioning	27
Setting system parameters	27
System parameter.....	28
Set ECO parameters.....	30
Network parameter settings.....	31
Completing the installation	31
Using the web user interface	32
Connecting to the web user interface	32
SNMP management	33
SNMP Trap address.....	33
System maintenance	35
Routine maintenance	35
Alarm fault handling.....	35
AC power failure.....	35
AC overvoltage fault	36
AC undervoltage fault	37
DC overvoltage fault	37
DC undervoltage fault	38
Rect fault	38
Rect protection fault	39
Rect comm fault.....	39
DC lightning protection board alarm	37
Identifying component faults.....	40
Identifying DC SPD faults	40
Identifying rectifier faults	40
Identifying controller faults.....	40

Introduction

This document provides overview, installation, commissioning, and maintenance information for the DC power system. Make sure the product is used in environments meeting its design specifications to avoid damaging components and voiding the warranty.

The illustrations in this document are for representation only and may not depict your product exactly.

General safety precautions

Read the instructions and notes carefully to reduce unexpected occurrences and comply with local laws and regulations. The safety instructions in this document are only supplements to local laws and regulations.

The items in the product and product manual do not represent all safety matters to be observed; they are only a supplement to the various operational safety considerations.

During the operation of the products and equipment, you must comply with the safety standards of relevant industries and strictly observe the relevant equipment and special safety instructions provided by the company.

FCC statements

This device complies with part 15 of the FCC Rules. Operation is subject to the following two conditions:

1. This device may not cause harmful interference.
2. This device must accept any interference received, including interference that may cause unrequired operation.

Modifications

Changes or modifications not expressly approved by the party responsible for compliance could void the user's authority to operate the equipment.

Never compromise the ground or earth connection of the product and they must be in place before connecting the power supply.



Warning! If not avoided, the following could result in death or serious injury.

- Only trained and qualified personnel can install, operate, and maintain equipment.
- Measure the contact point voltage with an electric meter before touching a conductor surface or terminal. Make sure the contact point has no voltage or it is within the specified range.



Caution! If not avoided, the following could result in minor or moderate injury.

- Do not operate the device or cables during thunderstorms.
- Remove metal objects such as watches, bracelets, and rings when using the product.



Notice. If not avoided, the following could result in property damage.

- Use insulated tools on the product.
- The load may power off during maintenance or fault location if the power system is not connected to a battery or if battery capacity is insufficient.
- Store cables for at least 24 hours at room temperature before laying out them if they were previously stored at sub 0°C (32°F).
- Routinely check installed equipment and perform maintenance according to the documentation. Replace faulty components to make sure the device works properly.

Electrical safety

Learn about the electrical safety requirements.

Grounding requirements



Caution! If not avoided, the following could result in minor or moderate injury.

- HIGH TOUCH CURRENT HAZARD! Connect to earth before connecting to supply.
- When installing a device, install the ground cable first. When removing a device, remove the ground cable last. Before operating a device, make sure the device is properly grounded.

Operational requirements



Warning! If not avoided, the following could result in death or serious injury.

- HIGH VOLTAGE HAZARD! Avoid direct contact or indirect contact with the power supply using wet objects.
- FIRE AND ELECTRIC SHOCK HAZARD! Irregular and incorrect operation can cause accidents.

Note the following operational requirements:

- The equipment is intended for installation in the Restricted Access area.
- AC power equipment installation must abide to the relevant industry safety standards. The personnel responsible for installing equipment must have high voltage and alternating current job qualifications.
- Before the equipment is electrically connected, disconnect the front protection switch from the device.
- Before connecting the AC, make sure the electrical connection of the equipment is completed.
- Before connecting the load (electrical equipment) to a cable or battery cable, confirm the polarity of the cable and terminal to prevent the reverse.
- Remove any metal objects such as watches, bracelets, and rings when using the product.
- If water is found in the cabinet or it is damp, immediately shut off the power.
- When operating in a humid environment, water must be strictly prevented from entering the equipment.
- During the installation process, switches and buttons not used during operation must have a prohibited sign attached to them.

ESD requirements

Note the following ESD requirements:

- To prevent electrostatic-sensitive components from being damaged by the static on human, wear a well-grounded ESD wrist strap or gloves when touching circuit boards. The other end of the anti-static wrist band must be grounded.
- When holding a board, hold its edge without components. Do not touch the chips.
- Package removed boards with ESD packaging materials before storage and transportation.

Liquid prevention requirements

Note the following requirements for preventing liquid from entering the product:

- Place the product away from areas with liquid.
- Do not place the product under positions prone to leakage, such as air conditioner vents, ventilation vents, and feeder windows of the equipment room.
- Prevent liquid from entering the inside of the product to avoid short circuits.
- Make sure no condensation is inside the equipment room or device.
- If any liquid is detected inside the device, immediately disconnect the power supply and contact the administrator.

Mechanical safety

Learn about the mechanical safety requirements.

Hoisting devices

Note the following requirements when hoisting devices:

- Only trained and qualified personnel can perform hoisting operations.
- Before hoisting objects, make sure the hoisting tools are firmly fixed onto a weight-bearing object or wall.
- Make sure the angle formed by the two cables is less than 90 degrees.

Using a ladder

Note the following requirements when using a ladder:

- Only use ladders in good condition.
- Do not exceed the maximum weight capacity.
- Christie recommends the angle for a ladder against another object is 75 degrees. Measure the gradient with a right angle or your arms, as shown below. Make sure the wider end of the frame is at the bottom so the base cannot slide and the ladder is securely positioned.

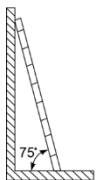

When climbing a ladder make sure you do the following:

- Make sure your body's center of gravity does not shift outside the legs of the ladder.
- Steady your balance on the ladder before performing any operation to minimize the risk of falling.
- Do not climb higher than the fourth rung from the top of the ladder.
- When climbing onto a roof, make sure the ladder top is at least one meter higher than the roofline, as shown below.

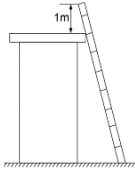

Moving heavy objects

Note the following requirements moving heavy objects:

- Use caution to prevent injury when moving heavy objects.
- Wear protective gloves when moving heavy objects.

Product overview

The Remote Power Rack Shelf is an embedded power supply system, which supplies power to communication equipment of +48V DC series. The maximum output current is 200A.

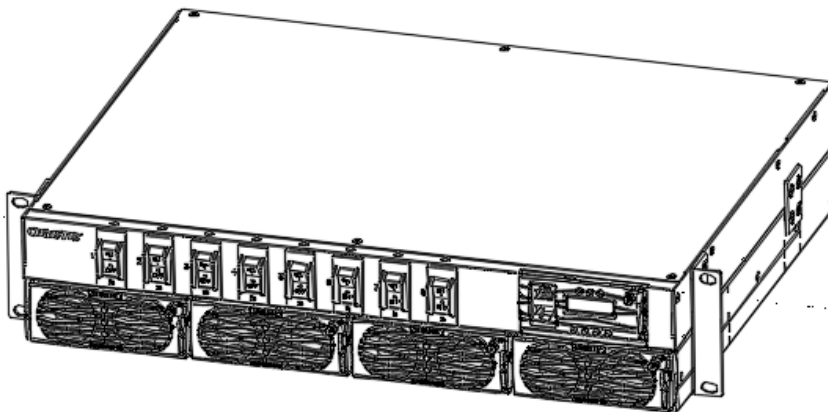

System features

Understand the important features of the Remote Power Rack Shelf.

- Wide range of AC input voltage to 85 VAC to 300 VAC (phase voltage)
- Network design provides the LAN and RS485 interfaces
- Supports the LCD interface display and keystrokes
- Hot plug support rectifier module
- Rectifier module power due to the value of 0.99

Product operation workflow

Learn how the product operates.

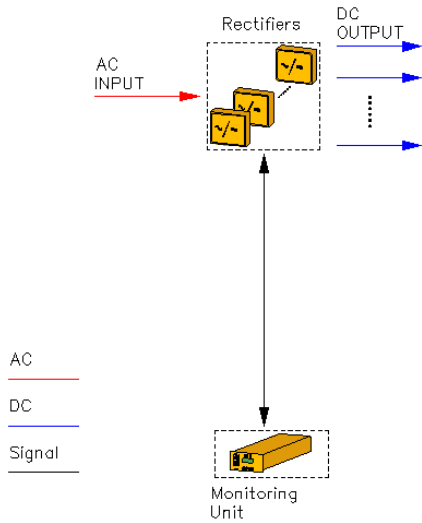

1. AC power enters the rectifiers through the AC input terminals.
2. The rectifiers convert the AC power input into 53.5 VDC power output, which is directed by the DC output terminals to DC loads along different routes.
3. When the AC power is normal, the rectifiers power the DC loads.
4. When the AC power is absent, the rectifiers stop working and the load does not work.

The rectifiers output 53.5V to supply power to the load only when the mains power is restored to normal.

5. The controlling unit controls the running state of each component of the power supply system in real time and carries out the corresponding intelligent control.
6. When detecting a fault, the controller generates an alarm.

Configurations

The following lists the product configurations.

Item	Description
Sub-rack	2U rectifier installation and controller unit space
Power distribution unit	AC power distribution—AC input terminals 4*16A DC power distribution—DC SPD, LOAD:8*25 (200A maximum)
Controller	MC2600
Rectifier	Four MR483000HG2B maximum
AC SPD	None
DC SPD	10kA,8/20µs

Components

The product has the following components:

- Interior structure
- Power distribution
- Rectifier
- Controller

Interior structure

Learn about the interior structure of the power supply system.



Before delivery, the NEG-busbar is short-circuited with the sub-rack PE by default.

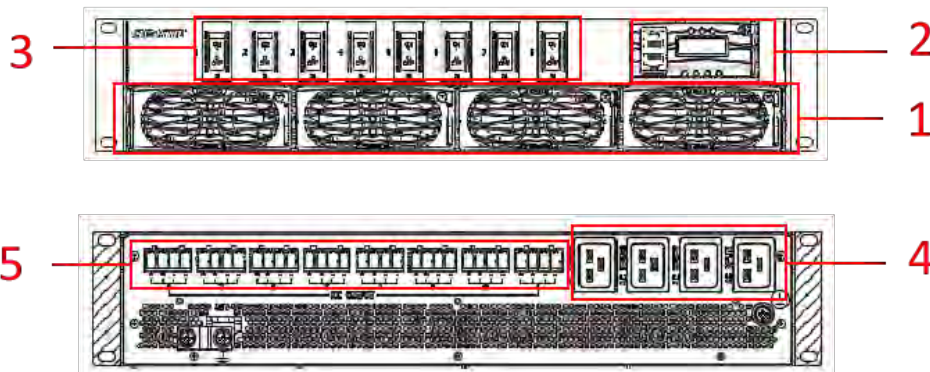

1	Rectifier
2	Controller
3	Breaker
4	AC input terminals
5	DC output terminals

Power distribution

Learn about the DC distribution unit of the power supply system. Four input connectors and four output terminals are behind the system and the maximum current of each input is 16A. Each output terminal has two outputs and the total current has a maximum of 25A.

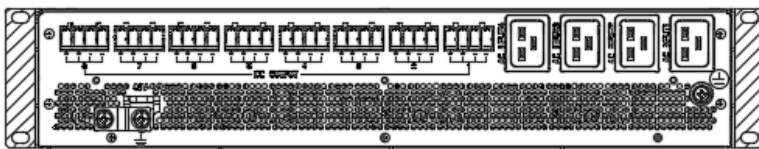

Item	Description
Input system	Nominal input: 100-130 VAC Derating output Nominal input: 200-240 VAC Full output Single-phase three wire system
AC power distribution	Four input connectors, maximum 16A for each input
DC power distribution	LOAD: 200A maximum (eight output terminals)

Rectifier

Learn about the rectifier of the power supply system. Three indicators are on the panel, which are used to reflect the operation status of the rectifier.

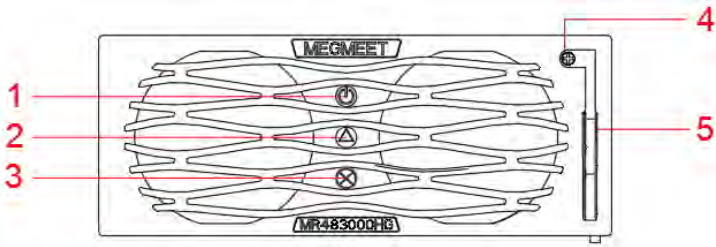

1	Power indicator
2	Alarm indicator
3	Fault indicator
4	Locking latch
5	Handle

Indicator	Color	Status	Reasons for status
Power indicator	Green	On	The rectifier has an AC power input.
		Off	Main supply fault (no AC input or OVP, UVP of AC input), non-output has occurred.
Alarm indicator	Yellow	On	Temperature alarm (OTP when the ambient temperature > 65°C) has occurred.
			The rectifier is hibernating (indicator lighting, no alarm).
			The rectifier is current limiting.
		Flickering	Communication failure has occurred.
		Off	No alarm is present
Fault indicator	Red	On	No output caused by module inner reason such as OVP, fan fault, and OTP.
		Off	The rectifier is running properly.

Controller

Learn about the controller of the power supply system.

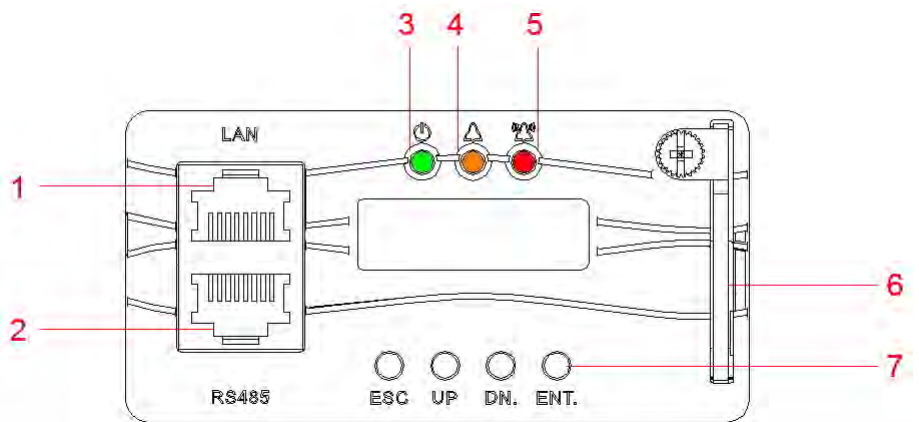
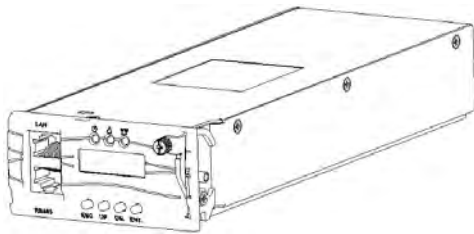

1	LAN port	3	Run indicator	5	Major alarm indicator	7	Buttons
---	----------	---	---------------	---	-----------------------	---	---------

2	RS485 port	4	Minor alarm indicator	6	Handle		
---	------------	---	-----------------------	---	--------	--	--



Controller buttons

The following provides the buttons used to operate the controller.

Item	Description	
ESC	Returns to the previous menu without saving the settings.	Press ESC and ENT at the same time shortly after restarting the controller.
ENT	Enters the main menu from the Standby screen. Enters a submenu from the main menu. Saves the menu settings.	
UP	Returns to the previous menu or sets the parameter values. When setting parameter values, press this button to adjust values.	When the parameter value is set by multiple string types, press Up or Down to change each value. After setting the value, press Confirm to move the cursor automatically back.
DN	Moves to the next menu or sets the parameter values. When setting parameter values, press this button to adjust values.	

Indicator

The following provides information about the indicators on the controller.

Type	Color	Status	Description
 Run indicator	Green	Flickering	Controller is running properly.
		Off	Controller has a fault or does not have a DC input.
 Minor alarm	Yellow	Normally on	The controller generated a minor alarm.
		Off	The controller did not generate any minor alarms.
 Major alarm	Red	Normally on	The controller generated a major alarm.
		Off	The controller did not generate any major alarms.

The controller provides two communication ports: the definition of RS485 communication port and the LAN Ethernet port interface definition.

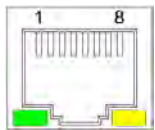

RS485 communication interface pin

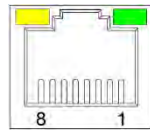

LAN Ethernet communication interface pin

The following shows the definition of the RS485 port:

Pin number.	1	2	3	4	5	6	7	8
Signal name	RS485+	-	RS485-	-	-	-	-	-

The following shows the definition of the LAN Ethernet port:

Pin number	1	2	3	4	5	6	7	8
Signal name	TX+	TX-	RX+	-	-	RX-	-	-

Technical specifications

Learn about the product technical specifications. Due to continuing research, specifications are subject to change without notice.

Environmental specifications

Learn about the environmental specifications while operating and not operating the product.

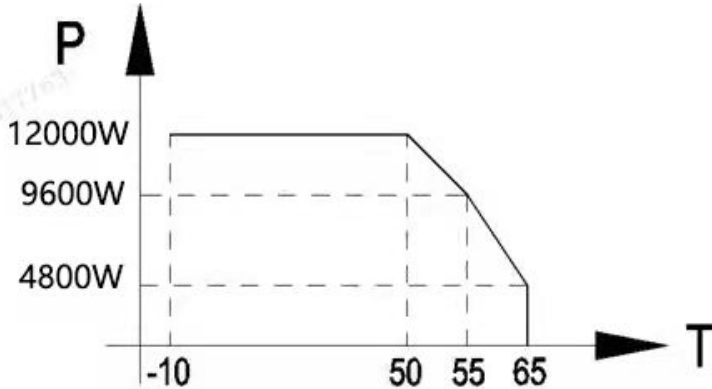

Item	Specification
Operating temperature	-10 to 65°C (14 to 149°F) 50 to 65 °C (122 to 149°F) derating work properly
Transportation temperature	-40 to 75°C (-40 to 167°F)
Storage temperature	-40 to 75°C (-40 to 167°F)
Operating humidity	5%RH to 95%RH
Storage humidity	5%RH to 95%RH
Altitude	0 to 4000 m (13,123.4 feet) Under 3000 to 4000 m (9842.5 to 13,123.4 feet), a high temperature derating exists, every 200 m (656.2 feet), working temperature by 1°C

Electrical specifications

Learn about the electrical specifications.

Item	Specification
AC input	Input system TT/TN Nominal input: 100-130 VAC derating output Nominal input: 200-240 VAC full output Single-phase

	Input frequency	50Hz (47-63Hz) Rated frequency: 50Hz/60Hz
	The power factor	≥0.99@220 VAC/full load
DC output	Output voltage range	42-58 VDC
	Output rated voltage	53.5 VDC
	Maximum power output	12KW The long-term working output current does not exceed 200A
	Voltage regulation accuracy	≤±1% The output voltage is stable in the range of 53.5 VDC ±0.1 VDC at half-load
	Peak to peak value noise voltage	≤200mV (rated input voltage and load range)
	The telephone weigh the noise voltage	≤2mV (300 to 3400Hz, the input voltage ≤260 VAC)
	Average current imbalance	≤±5% (176 to 90 VAC, 50% to 100%Load)
AC input protection	AC input overvoltage protection point	310±10 VAC
	AC input overvoltage recovery point	290-300 VAC
	AC input under voltage protection point	80±5 VAC
	AC input under voltage recovery point	80-90 VAC
DC output protection	DC output overvoltage protection point	60±2V (lock)
Rectifier module	Efficiency	The highest point ≥96%; ≥95% (220 VAC, 30% to 100% load)
	The output power	3000W (176-290 VAC) 1250W (85-176 VAC linear derating)
	Overvoltage protection	The module locks up when the voltage is over voltage The external voltage is above 60±2 VDC and lasts above 500ms, the module is locked.
EMC specifications	Conducted interference	AC port EN 55032 class A
		DC port EN 55032 class A
	Radiated interference	EN 55032 class A
	Harmonic current	IEC 61000-3-12
	Voltage flicker and wave	IEC 61000-3-3
	Electrostatic discharge resistance (ESD)	IEC 61000-4-2 shell port contact discharge 6kV, air discharge 8kV, signal port contact discharge 2kV
	Electrical fast pulse group disturbance rejection (EFT)	IEC 61000-4-4 AC/DC power port 2kV
Radiation immunity (RS)	IEC 61000-4-3 10V/m magnetic field intensity	

	Conduction immunity (CS)	IEC 61000-4-6—The power port meets the requirement of 10V and the signal port meets the requirement of 3V
	Surge immunity (SURGE)	IEC 61000-4-5 AC/DC power port differential mode 2kV, total mode 4kV,8/20µs
	Voltage dip and break Off during short circuit (DIP)	Meet IEC 61000-4-11 standard requirements
Other	SPD	DC SPD protection: 10kA,8/20µs
	Safety design	Meet the standard IEC/EN/UL62368-1/GB 4943
	Insulation resistance	Remove the controller and rectifier module, lightning protection module, DC part, AC part and the chassis of the insulation resistance between > 10mΩ (test voltage 500 VDC)
	Dielectric strength	Apply 3000 VAC (or 4242 VDC) to AC input and DC output. The AC part is applied to the enclosure with 1500 VAC (or 2121 VDC). Apply 500 VAC (or 707 VDC) between DC output and PE. No breakdown of flight arc and leakage current is less than 10mA.

System power conversion point

The following illustrates the AC input derating curve.

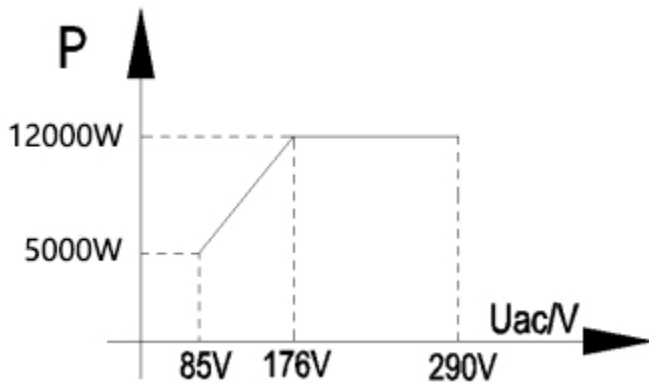

Mechanics specifications

Learn about the mechanical specifications.

Item	Specification
Power system(H×W×D)	88 x 482.0 x 349.2 mm
Weight	≤10 kg (rectifier modules are not included)
Protection grade	IP20
Installation	Support 19-inch rack mounting
In and out mode	Into the line behind, out the line behind

Maintenance mode	In front of the maintenance
Cooling way	Natural cold

System installation

This section describes the installation requirements, cable connection, and installation instructions.

Installation requirements



Warning! If not avoided, the following could result in death or serious injury.









- Only trained and qualified construction personnel can perform the installation.

Before installation, review the following items:

- Technical engineers must be trained and familiar with the proper installation and operational methods.
- The number of installation personnel varies based on the project and the installation environment. Typically, two to four people are required for installation.

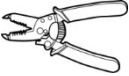
Required tools

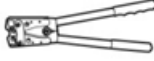
The following lists the tools and meters required for installing the product.

Tools and meters				
Flat-head screwdriver 	Phillips screwdriver 	Utility knife 	Insulation gloves 	Insulation protective shoes 
Wire stripper 	Heat shrink tubing 	Wire cutters 	Crimping pliers 	Cable lacing bar 
Cable tie 				

Rack mounting safety instruction

Note the following requirements for the rack mounting:

- When installed in a closed or multi-unit rack assembly, the operating ambient temperature of the rack environment may be greater than the room ambient. Consider installing the equipment in an environment compatible with the maximum ambient temperature (T_{ma}) specified by the manufacturer.
- Install the equipment in a rack so the amount of air flow required for the safe operation of the equipment is not compromised.

- Mount the equipment in the rack so a hazardous condition is not created due to uneven mechanical loading.
- Consider the connection of the equipment to the supply circuit and the effect that overloading of the circuits might have on overcurrent protection and supply wiring. Consider the equipment label ratings when addressing this concern.
- Reliable earthing of the rack-mounting equipment must be maintained. Pay particular attention to supply connections other than direct connections to the branch circuit (for example, use of power strips).

Cable routing requirements

Note the following requirements for cable routing:

- Cables must be more than 20 mm (0.8 inches) away from heat sources to prevent insulation layer damage (melting) and functional degradation (aging or breakage).
- The bending radius of cables must be at least five times the diameter of the cables.
- Cables of the same type must be bound together.
- Cables of different types must be a minimum of 30 mm (1.2 inches) from each other to avoid tangling.
- Cables bound together must be close to each other, tidy, and undamaged.
- Ground cables must not be bound to or tangled with signal cables. Maintain an appropriate distance between the cables to minimize interruptions.
- AC power cables, DC power cables, signal cables, and communications cables must be bound separately.
- Power cables must be routed straight. No joints or welding should exist on power cables.
- Use a longer cable if necessary.

Installing the sub-rack

The following shows the planned installation space for the sub-rack.

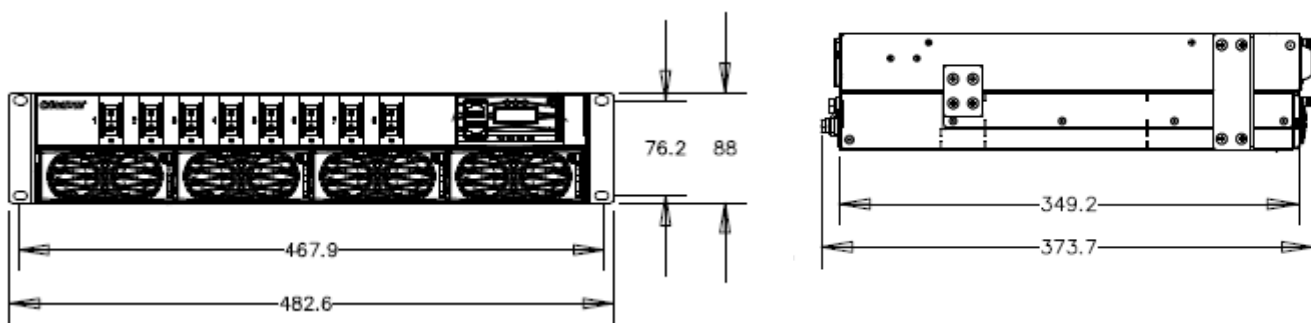

Unpacking and acceptance

Follow these steps to unpack and accept the sub-rack.

1. Check if the packing boxes are intact.

If the packing box is seriously damaged or wet, determine the reason and provide feedback to Christie.

2. Open the box.
3. Check the number of parts on the packing list.

If the quantity in the box is different from the packing list, determine the reason and provide feedback to Christie.

Installing the sub-rack

Install the sub-rack to the 19-inch rack.

1. Remove the plug from the package.
2. Push the plug into the 19-inch rack.
3. Install the fixed screw.

If the mounting hole of the plug frame ear does not correspond to the position of the floating nut of the frame, it must be adjusted according to the actual installation.

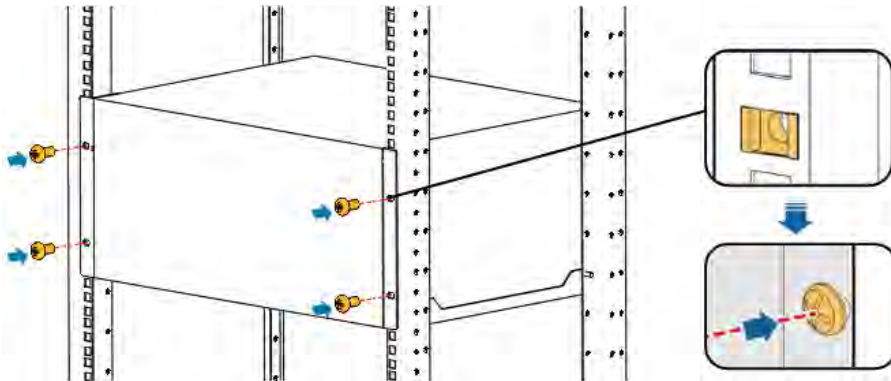

Installing the ground cable

Next, install the ground cable.



Caution! If not avoided, the following could result in minor or moderate injury.

- Make sure the ground cable is installed securely to avoid device damage or personal injury.

1. Connect one end of the protective ground wire to the M6 screw on the PE row in the insert box.
2. Connect the other end of the protection ground wire to the ground set screw on the cabinet/rack.

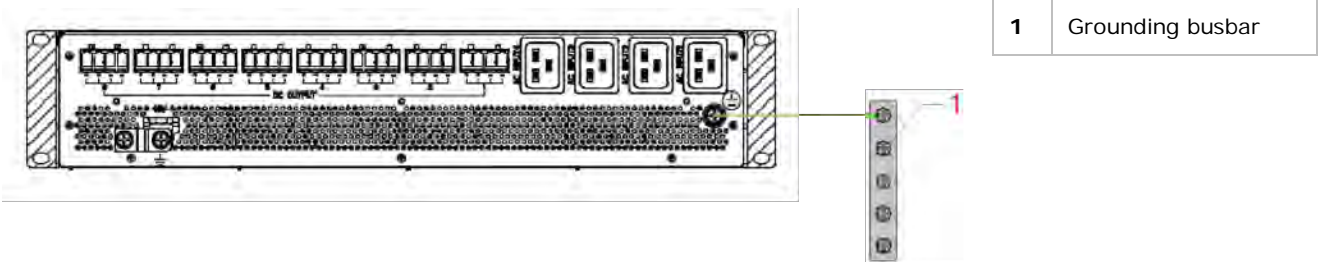

Installing the rectifier

After installing the ground cable, install the rectifier.



Caution! If not avoided, the following could result in minor or moderate injury.

- ELECTRIC SHOCK HAZARD! Do not insert your hand into the slot of the rectifier module.
- Only professional maintenance staff can hot plug.

1. Remove the rectifier from the package.
2. Holding the rectifier handle on the front panel, place the rectifier into the slot.
3. Push the rectifier module slowly to the front panel of the module and flush with the power distribution panel.
4. Tighten the fixing screw on the rectifier panel so the rectifier does not come off.

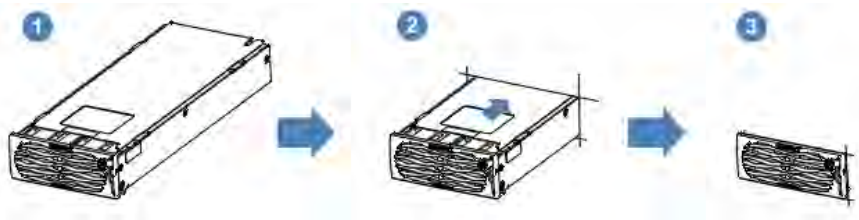

Installing the communication cables

The Power Shelves are not required to be connected on the network to function properly. They must be connected to a network if remote SNMP monitoring is required.

The Power Shelves can be connected to the following:

- Corporate network using a router
- An isolated network

Network setup using a wired router

To separate the Power Shelves from the corporate network traffic, while maintaining the ability to report possible issues, a router must be used (the laptop is only used to configure the router).

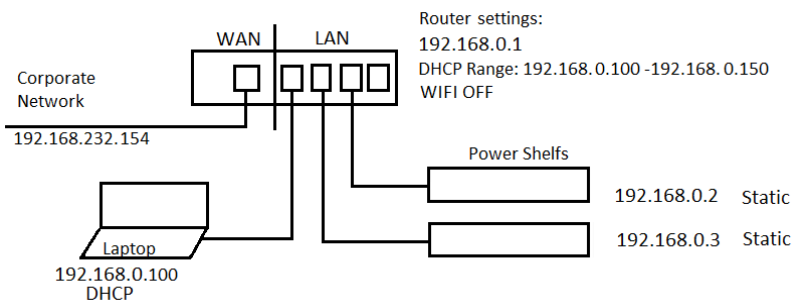

Network router configuration

Any wired router with port forward functionality can be used. For this document, the screenshots used are from a [TP-Link router](#).

1. Login to router’s web interface and disable the wireless functionality (WiFi) if the functionality exists.
The wireless functionality is not be used for this setup.
2. For the LAN network, setup the router IP address to 192.168.0.1, with subnet mask 255.255.255.0. P
3. Record the WAN IP address of the router connected to the corporate network.

This is usually displayed on status page and is the IP address used to access the SNMP data from the rectifiers (192.168.232.154 in the image on page 21).

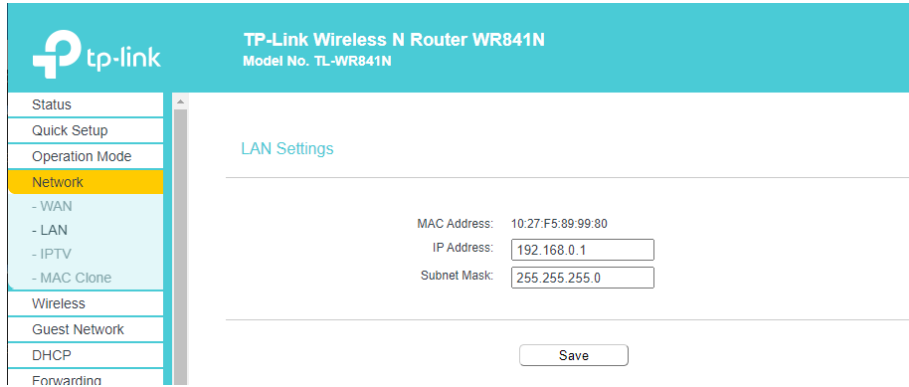

4. If using a laptop without a static IP address to configure the router, enable the DHCP.
Otherwise, the DHCP functionality is not required.
5. On the DHCP page, enable the DHCP feature to allow the router to allocate IP addresses in the range 192.168.0.100 to 192.168.0.150 so it does not overlap with the static IP addresses used for the power supplies.

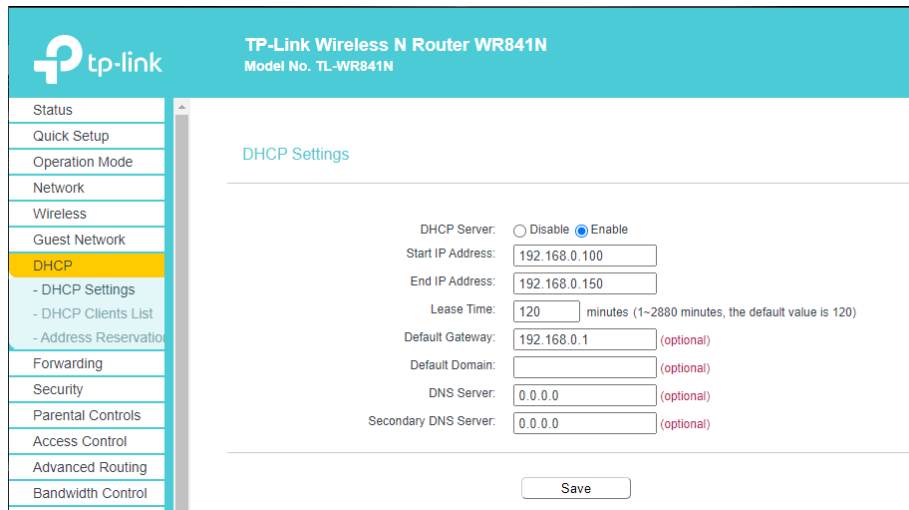

6. To get data using an SNMP client, forward port 161 for each Power Shelf installed.

Once these changes are set, the SNMP data is not accessed using port 161, which is the common port for SNMP, but using the forwarded ports from the router. For example, to access the SNMP data from the Power Shelf 192.168.0.2, using port 161, the SNMP client must access it using the router IP address, using port 171

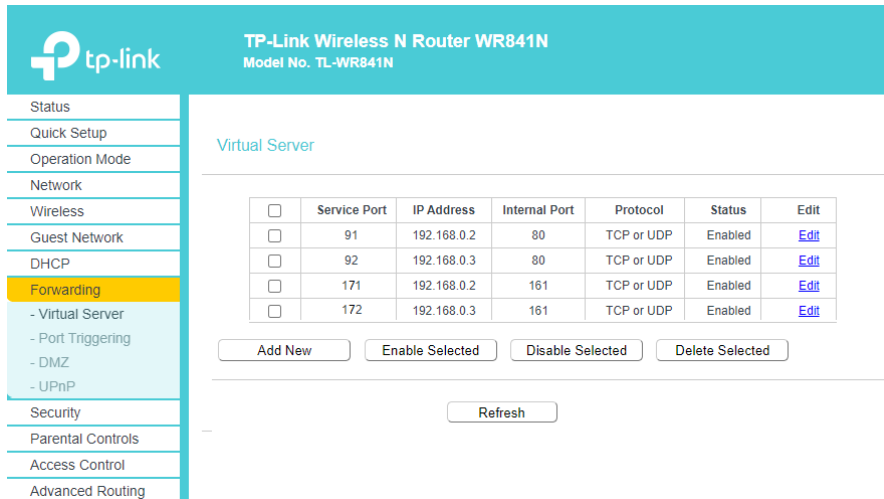

Network setup using a separate network

If the power shelves do not need to be connected on the corporate network, they can be connected directly to a local computer using a regular network switch. The IP address for the local computer must be in the same subnet as the power shelves (192.168.0.1), while a second network connection can be used to connect the laptop to corporate network.

Using this setup, the SNMP client must be installed on the laptop connected to the Power Shelves. A different static IP addresses must be set for each Power Shelf.

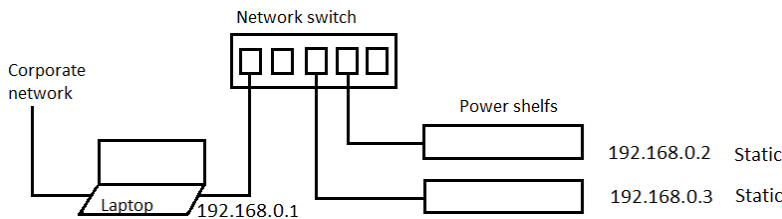

If only one Power Shelf is part of the installation, it can be connected directly to the computer.

1. Connect one end of the ethernet cable to the Ethernet port of the controller.
2. Connect the other end of the cable to the upper computer network port.

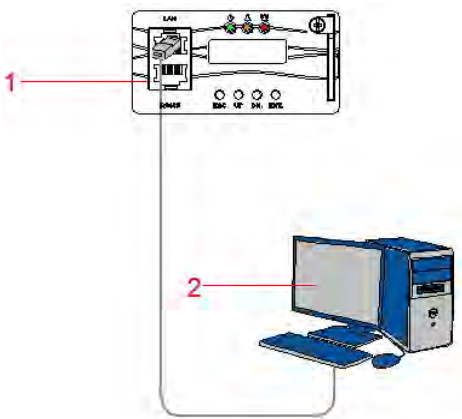

1	Ethernet port
2	Upper computer

Installing the DC cable

The output cable cannot block the sub-rack air outlet. If making your own custom cable make sure your wire follows the following specifications:

- For aluminum conductors, only use aluminum conductors, or only use aluminum or copper-clad aluminum conductors.
- For copper and aluminum conductors, use copper or aluminum conductors or use copper, copper-clad aluminum conductors.
- Use a 10 AWG with minimum 75°C (167°F) rated DC cable
- Continue on step 2 below for installing cable into a Degcon connector

If pre-cut DC cables were ordered with four wires Molex connectors, the Molex connectors must be replaced with a four wires Degcon connectors. Do not remove the Molex connectors with two wires.



Molex

Degcon

Follow these steps to cut off Molex connector(s):

1. Strip the wire insulation to expose approximately 5 mm of copper.
2. Insert the red wires in + position and black wires in – position.
3. Use a small flathead screwdriver to secure the wire to the terminal block.
4. Insert the terminal block into the mating connector located on the rear of the Power Shelf.
5. Use a cable management lacing bar to secure the DC cables to the rack to avoid disconnecting from the output terminal.

1	DC load
----------	---------

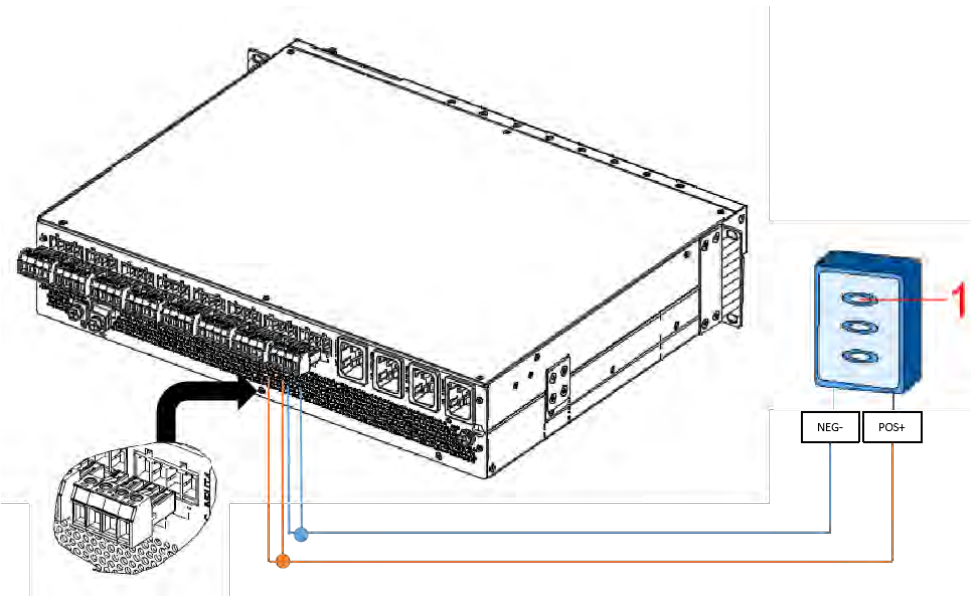

- The positive and negative pole wiring at the output end match the silk screen printing on the sub-rack.
- Client output terminal model:
 - Shell: DEGSON (5EDGRC-7.62-02P-14-00A(H))
 - Terminal: DEGSON (5EDGK-7.62-02P-14-00A(H))

Installing the AC cable

After installing the DC cable, install the AC cable.



Warning! If not avoided, the following could result in death or serious injury.

- Make sure the front AC input is left open in an off state and hang a prominent Do not operate sign.
- Turn off all MCBs before installing the cables.



Notice. If not avoided, the following could result in property damage.

- The input cable cannot block the sub-rack air outlet.

1. Connect the 220 VAC single-phase AC input cable to the client connector.
2. Plug and play the client and input connectors to complete the input wiring.

1	AC distribution box/cabinet
----------	-----------------------------

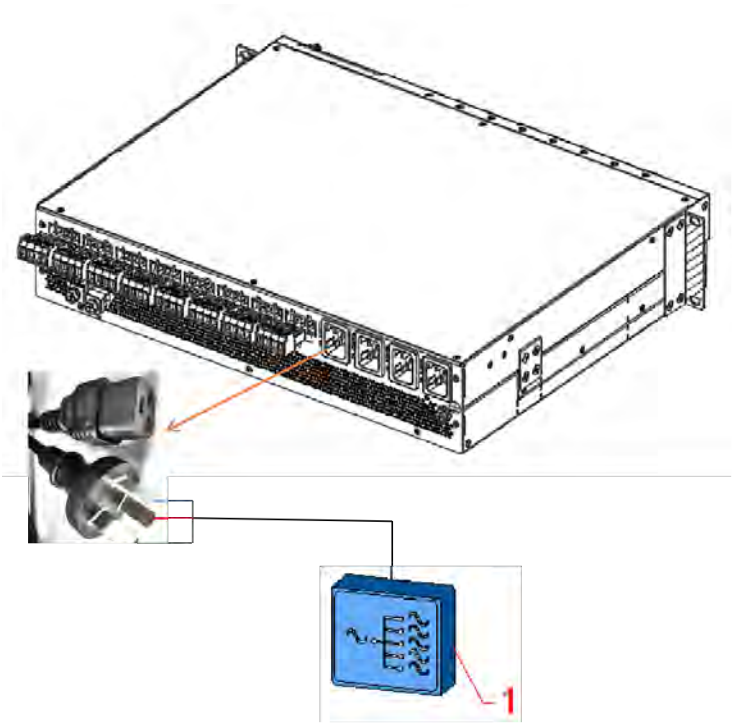

The client connector model IEC C20 is a 1P3W power line (16A).

Inspecting the installation

After the installation is complete, inspect the hardware, electrical, and cable installations.

1. Check the hardware installation.
 - a. Verify all screws are properly fastened.
 - b. Verify the rectifier module is fully inserted into each slot and locked correctly.
2. Check the electrical connection.
 - a. Verify the input and output power and ground cables are properly connected.
3. Check the cable installation.
 - a. Check the installation of the cables.
 - b. Verify all cables are lined up neatly and tightly connected to their nearest cables, without twisting or bending.
 - c. Check the cable label is correct, firm, and consistent.

System check

This section provides information about the system test to be run after installation:

- The adjustment process does not cut off power. Stand on the dry insulation during operation and do not wear metal objects such as watches and necklaces.
- Tools must be insulated.
- During operation, if no one else is allowed to operate the product, hang a sign on the distribution equipment such as *Do not close; operation in progress*.

Power on commissioning

Follow these steps to check the power on commissioning.

1. Check or measure the grounding performance of the equipment and if a short circuit exists.
2. Measure the AC input phase voltage between 85-300 VAC.
3. Check the running indicator light (green) of the rectifier.
The indicator light should be in a constant light state.
4. Wait approximately one minute and measure the voltage between the loads positive and negative poles, which should be between 48 and 54 VDC.

Setting system parameters

When the monitoring module is powered on, the information display screen appears as illustrated below.

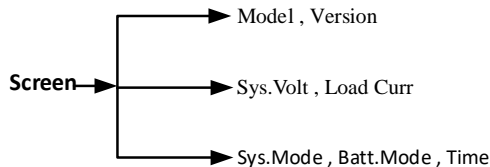

The system information screen shows the main information, including system voltage, load current, and system control mode. System control mode can be Auto or Manual.

The setting system menu requires a login. If no button operation occurs within two minutes and no operation on the controller button occurred within eight minutes, you are logged out of the setting system menu.

The default password to changing settings on the controllers unit is 2.

1. To select the parameter to set, press **UP** or **DN**.
2. To confirm, press **ENT**.
3. To select the parameter again, press **UP** or **DN**.
4. To confirm and save, press **ENT**.

System setting tree

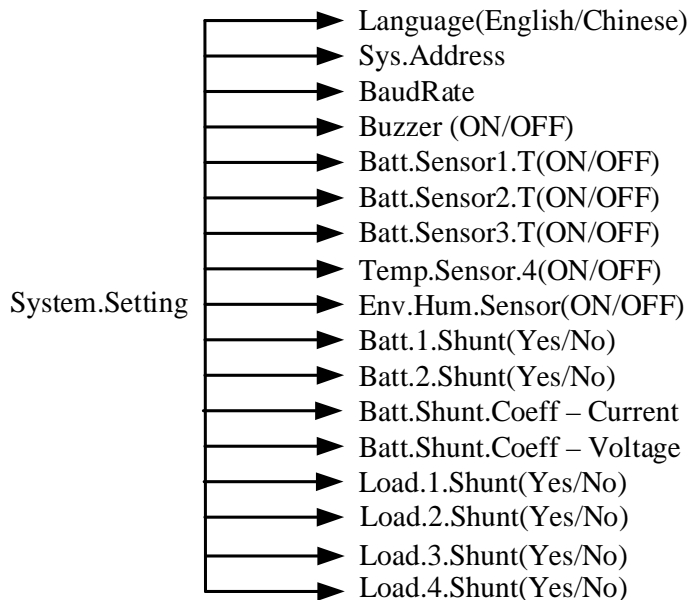

The **Menu > System Setting** screen is mainly used to set parameters according to system hardware configuration and to reduce part of the system functions to make sure the system is running well.

System parameter

The following table describes the system parameters available for use.

Parameter name	Setting range	Description
Language	Chinese English (Default)	Sets the system language.
Sys.Address	0 to 255 1 (Default)	Provides the controller communication address.
BaudRate	2400bps 4800bps 9600bps (Default) 19200bps 38400bps	Sets the serial communication baud rate for the RS485 port on front panel.
Buzzer	ON (Default) OFF	ON—Opens the voice alarm function. OFF—Closes the voice alarm function.
Batt.Sensor1.T	Batt No (Default)	Batt—Enables sensor 1 for battery temperature. No—Disables sensor 1 for battery temperature. Use the Temperature compensation function for the VRLA battery if the power system has a battery temperature sensor 1.
Batt.Sensor2.T	Batt No (Default)	Batt—Enables sensor 2 for battery temperature. No—Disables sensor 2 for battery temperature. Use the Temperature compensation function for the VRLA battery if the power system has a battery temperature sensor 2.

Batt.Sensor3.T	Batt No (Default)	Batt—Enables sensor 3 for battery temperature. No—Disables sensor 3 for battery temperature. Use the Temperature compensation function for the VRLA battery if the power system has a battery temperature sensor 3.
Temp.Sensor.4	Yes No (Default)	Set according to need.
Env.Hum.Sensor	Yes No (Default)	
Batt.1 Shunt	Yes (Default) No	Set according to the actual power system. Battery shunt must be set to No if the system does not sample using shunt.
Batt.2 Shunt	Yes No (Default)	
Batt.Shunt Coefficient -Current	1 to 2000A 500A (Default)	Set according to the actual power system.
Batt.Shunt Coefficient -Voltage	1 to 500mV 25mV (Default)	
Load 1 Shunt	Yes No (Default)	Set according to the actual power system. If all the load shunts are set to No , the total load current is equal to the sum of module currents minus the sum of battery currents.
Load 2 Shunt	Yes No (Default)	
Load 3 Shunt	Yes No (Default)	
Load 4 Shunt	Yes No (Default)	
Load Shunt Coefficient -Current	1 to 2000A 300A (Default)	Set according to the actual power system. These two parameters are invalid if all load shunts are configured as No .
Load Shunt Coefficient -Voltage	1 to 500mV 25mV (Default)	
System Type	24V 48V (Default)	Set according to the actual situation.
Batt Contactor	NC NO (Default)	Indicates if the battery contactor type is normally open.
Load OverCurr	80% to 120% 100% (Default)	Indicates the system overload alarm percentage. For example, if the load overcurrent alarm value is 80% in a 200A system, when the load current is more than 160A, the load overcurrent alarm appears. If the load overcurrent alarm value is 100% in 200A system, when the load current is more than 200A, the load overcurrent alarm appears.
Exit Manual	None 30 minutes (Default) 1 hour 2 hour 4 hour	Configures the Manual to auto mode timer. None—Manual mode is not switched to Automatic mode unless a DC undervoltage alarm exists.
Clear History	Yes No (Default)	Clears the all history alarm record.
Clear UsedEnergy	Yes	Clears the all used energy record.

	No (Default)	
Clear TestRecord	Yes No (Default)	Clears the all battery test record.
Clear DataRecord	Yes No (Default)	Clears the all history data record.
Reset Default	Yes No (Default)	Resets the system factory default setting.
Clear Rect Alarm	Yes No (Default)	Clears the all rectifiers alarm.
System Restart	Yes No (Default)	Restarts the system controller.
Software Update	Yes No (Default)	Updates the software. Only trained operators can perform this task.
Set password	No more than six digits or characters 2 (Default)	Enter a password to set parameters and controls. If a button operation does not occur for more than two minutes, you must re-enter the password.
S.Type	Only Mains Only PV Only DG Mains_DG Mains_PV DG_PV Mains_DG_PV (Default)	Indicates the hybrid power system energy input sources type. Note the following: <ul style="list-style-type: none"> • Mains means AC voltage input. • PV means solar panels. • DG means diesel generators.
Log Record Time	5 to 1440 minutes 10 minutes (Default)	History data logs record period Time.

Set ECO parameters

In ECO mode, the monitoring module controls part of the rectifier module to close, so the running rectifier module bears all the load. When the battery current or load current changes in the system, the control module closes the working rectifier module according to the actual situation or the control module opens and starts working. The system makes sure at least one rectifier module is working properly.

Parameter name	Setting range	Description
Sleep	Enable Disable (Default)	Enable—Uses fast test function. Disable—Does not use the fast test function. Only set to Enable if the system has a battery and no large load current shock appears.
Period Time	1 to 8760h 168h (Default)	Also known as cycle activation time. To synchronize the life of all the rectifier modules, you must operate the module with a long sleep time at a certain time interval while allowing the module to have a long working time to sleep. This time interval is the cycle activation time.
Dry time	10 to 240 minutes 120 minutes (Default)	After exiting the last Sleep mode, indicates the work time of rectifiers on the No Sleep mode.

		You can enter Sleep mode again when more than the dry time has occurred.
Rect Save Start	30% to 90% 60% (Default)	Also known as the rectifier best operating-point. At the best operating-point the rectifier module operates at a relatively high efficiency and is subject to more suitable stresses. For energy saving, the power supply system must make the rectifier module load/rated capacity ratio as close as possible to the best operating-point. Load/rated capacity ratio = Rectifier real output current/rectifier rated current * 100%.
Rect Save Stop	30% to 100% 90% (Default)	Also known as system energy-saving point. If the load/rated capacity ratio is more than the system energy-saving point, the power supply system exits Energy-saving mode.
Min.WorkRect Num	1 to 20 2 (Default)	Indicates the minimum number of rectifiers working.

Network parameter settings

A static IP addresses must be assigned to each Power Shelf. By default, they are programmed with the default IP address 192.168.70.2.

The following table describes the network parameters available for use.

Parameter name	Default value	Description
IP Address	192.168.70.2	Set according to need.
Netmask Address	255.255.255.0	
Gateway Address	192.168.70.1	
Trap Address1	0.0.0.0	Set the host address 1 of SNMP active report alarm.
Trap Address2	0.0.0.0	Set the host address 2 of SNMP active report alarm.

Completing the installation

Complete these steps when the installation is done.

1. Replace the removed panel or cover board.
2. Keep the external paint of sub-rack intact.
3. If any paint is removed, repaint the part immediately to prevent corrosion.
4. Clean up and exit the site.

Using the web user interface

Through the web user interface, users can achieve the following functions:

- View real-time data and status.
- Set system parameters.
- Pop up the current alarm information automatically.
- Check history warning information.
- Upload or download configuration files and upgrade the system.

Connecting to the web user interface

The default IP address for the control unit is 192.168.70.2. The default username and password combination is *admin* and *654321*.

The IP address can be changed from the front panel or web user interface. To connect to the control unit's web user interface, make sure to set your computer to a correct IP address, in the same subnet (for example, 192.168.70.100).

This web user interface provides a full function to the customer. Using a PC-connected internet, control the power system, view the working status, change the parameters, and download the Alarm history record.

The following shows the web user interface:

The screenshot displays the web user interface with the following sections:

- System Status:** System Voltage: 50.5V, System Load: 29.4A, Battery Current: 18.1A, Battery Mode: Float, Alarm State: Major.
- Modules Settings:**
 - Control Mode: Auto (Set)
 - Manual Mode Control: Floating Ch. (Set)
 - Rectifier Number: 8 (Set)
 - Solar Number: 0 (Set)
 - Rectifier Start Mode: Pocl (Set)
 - Rectifier Output Over Voltage: 60.5V (Set)
 - Rectifier Output Voltage: 50.7V (Set)
 - Current Limit Point: 23.3% (Set)
 - Walk-In: (Set)
- Rectifier Module Information:**

Module Num	Vin/V	Vout/V	Iout/A	Power/AW	Temper/deg.C	On/Off Status	Serial Number (Module Type)	On/Off Control
Rect #1	235.4	50.7	12	0.607	32.4	On	18172070419193300010 (Rectifier)	On (Set)
Rect #2	235.2	50.7	11.9	0.601	32.1	On	18172070419193300051 (Rectifier)	On (Set)
Rect #3	234.2	50.7	11.8	0.599	31.9	On	18172070419193300049 (Rectifier)	On (Set)
Rect #4	234.2	50.7	11.8	0.6	32.5	On	18172070419193300060 (Rectifier)	On (Set)
---	---	---	---	---	---	---	---	On (Set)
---	---	---	---	---	---	---	---	On (Set)
- Navigation Menu:**
 - Input
 - Diesel
 - DC
 - Modules
 - Battery
 - Charge
 - LVD
 - Test
 - Temperature
 - ECO
 - Communication
 - Alarm
 - Active Alarm
 - History Alarm
 - Data Log
 - Battery Log
 - Alarm Config
 - System
 - Up/Download

System Voltage: 50.5V	System Load: 29.8A	Battery Current: 18A	Battery Mode: Float	Alarm State: Major
-----------------------	--------------------	----------------------	---------------------	--------------------

- Input
- Diesel
- DC
- Modules
- Battery
 - Charge
 - LVD
 - Test
 - Temperature
- ECO
- Communication
- Alarm
 - Active Alarm
 - History Alarm
 - Data Log
 - Battery Log
 - Alarm Config
- System
- Up/Download

Active Alarm List

Active Alarm Number : 3

AlarmNo	AlarmName	BeginTime	AlarmLevel
1	PV Vin Fail	2020-01-09 14:17:16	Major Alarm
2	DG Running	2020-01-09 14:16:52	Minor Alarm
3	Digital Alarm	2020-01-09 14:16:52	Minor Alarm

SNMP management

SNMP is a technology used for network management. The technology is based on implementing an information base called MIB (Managed Information Base), which contains parameters. All LAN connected equipment supporting SNMP, also supports a default MIB called MIB-II.

The SNMP Agent responds to requests received using the SNMP protocol and also actively sends traps to a specified manager when certain MIB values change state. This is used to actively inform a manager when an alarm situation is recognized. The SNMP protocol supports SET/GET and TRAP.

SNMP communication can be established using a LAN.

SNMP Trap address

SNMP trap addresses can be set on the LCD or using the communication screen of web user interface, for up to two computers or servers.

The screenshot shows the 'Communication Settings' page in the web user interface. At the top, there are status indicators: System Voltage: 54V, System Load: 0A, Battery Current: 0A, Battery Mode: Float, and Alarm State: Major. The page is divided into several sections:

- Communication Information:** MAC Address: 4.145.98.22.158.253
- IP Settings:** IP Address: 192.168.70.2, SubNet Mask: 255.255.255.0, Gateway: 192.168.70.1
- Communication Settings:**
 - SNMP Trap Destination1: 0.0.0.0
 - SNMP Trap Destination2: 0.0.0.0
 - Address: 1
 - Band Rate: 9600
 - SNMP Community String: public
 - Reset SNMP Trap

The remote computer can also get DC voltage, load current, battery current, the voltage current of each module, and system status information by SNMP protocol.

An MIB file must be loaded in the SNMP agent to get SNMP data formatted properly. The MIB file can be downloaded from Christie's web portal.

The password to access SNMP data is *public* and the SNMP version must be set to 2.

Advanced Properties of SNMP Agent

Address: 192.168.232.154

Port: 161

Read Community: public

Write Community: public

SNMP Version: 2

Ok Cancel

System maintenance

System maintenance is important to make sure the proper working of the product.

Routine maintenance

On a routine basis, perform these maintenance items.

Maintenance item	Maintenance content			
	Check item	Check method	Repair condition	Processing method
Electrical	Is the voltage output normal?	Multi-meter	The battery branch or load branch voltage exceeds the set range.	Refer to Alarm fault handling section on page 35.
The fault inspection	Is the indicator light normal?	Visual	Indicates a failure warning.	—
Appearance	Are there any scratches or peeling of the power system coating?	Visual	The power system looks damaged or deformed.	Repaint and repair the housing.
Grounding detection	Is the power supply is connected to the grounding bar of the machine room?	Visual Screwdriver Wrench Other tools	Check the power connection point and the grounding bus of the machine room. The cable connection is not reliable.	Retighten the grounding point or replace the grounding cable.

Alarm fault handling

This section provides guidelines to help troubleshoot various alarm faults.

AC-L1 Under Volt fault

An AC-LI Under Volt fault has occurred.

Details

- Can be L1, L2, or L3.

Resolution

1. Log into the Remote Power Shelf Rectifier.
2. Navigate to **Input**.
3. In the AC Under Volt field, enter 90.
4. Select **Set**.

AC-L1 Over Volt fault

An AC-LI Over Volt fault has occurred.

Details

- Can be L1, L2, or L3.

Resolution

1. Log into the Remote Power Shelf Rectifier.
2. Navigate to **Input**.
3. In the AC Over Volt field, enter 280.
4. Select **Set**.

AC-L3 Ph. Fail

An AC-L3 Ph. failure has occurred.

Resolution

1. Log into the Remote Power Shelf Rectifier.
2. Switch to **Input**.
3. From the AC Under Volt field, select **PH-1**.
4. Select **Set**.

AC power failure

An AC power failure has occurred and an AC power fault has occurred.

Details

- The AC input power cable is faulty.
- The mains grid is faulty.

Resolution

- Check if the AC input cable is loose. If yes, secure the AC input cable.
- Check if the AC input voltage is lower than 50 VAC. If yes, handle the mains grid fault.

AC overvoltage fault

An AC overvoltage alarm has occurred.

Details

- The AC overvoltage alarm threshold is not set properly on the controller.
- The power grid is faulty.

Resolution

- Check if the AC overvoltage alarm threshold is properly set. If no, adjust it to a proper value.
- Check if the AC input voltage exceeds the AC overvoltage alarm threshold (280 VAC by default). If yes, handle the AC input fault.

AC undervoltage fault

An AC undervoltage alarm has appeared.

Details

- The AC undervoltage alarm threshold is not set properly on the controller.
- The power grid is faulty.

Resolution

- Check if the AC undervoltage alarm threshold is properly set. If no, adjust it to a proper value.
- Check if the AC input voltage is below the AC undervoltage alarm threshold (180 VAC by default). If yes, handle the AC input fault.

DC lightning protection board alarm

A DC lightning protection board alarm has been triggered.

Details

- The DC lightning protection board is faulty.
- The DC lightning protection detection cable is disconnected.

Resolution

- Check if the positive and negative poles of the DC lightning protection board are turned on. If yes, replace the DC lightning protection board.
- Check if the DC lightning protection board detection cable is disconnected. If yes, reconnect the cable.

DC overvoltage fault

A DC overvoltage alarm has appeared.

Details

- The DC overvoltage alarm threshold is not set properly on the controller.
- The power system voltage is set too high in manual mode.

- The rectifiers are faulty.

Resolution

- Check if the DC overvoltage alarm threshold (58 VDC by default) is properly set. If no, adjust it to a proper value.
- Check if the system voltage is set too high in Manual mode. If yes, confirm the reason and adjust the voltage to normal after the operation.
- Remove the rectifiers one-by-one and check whether the alarm is cleared. If the alarm still exists, re-install the rectifier. If the alarm is cleared, replace the rectifier.

DC undervoltage fault

A DC undervoltage alarm has appeared.

Details

- AC power failure occurs.
- The DC under voltage alarm threshold is not set properly on the controller.
- The system configuration is not proper.
- The power system voltage is set too low in Manual mode.
- The rectifiers are faulty.

Resolution

- Check if an AC power failure occurred. If yes, restore the AC power supply.
- Check if the DC under voltage alarm threshold (45 VDC by default) is properly set. If no, adjust it to a proper value.
- Check if the load current is greater than the current power system capacity. If yes, expand the power system capacity or reduce the load power.
- Check if the system voltage is set too low in manual mode. If yes, confirm the reason and adjust the voltage to a proper value after the operation.
- Check if the power system capacity is insufficient for the loads due to rectifier failures. If yes, replace the faulty rectifier.

Rect fault

A Rect fault has occurred.

Details

- The rectifier has poor contact.
- The rectifier is faulty.

Resolution

- Check the fault indicator on the rectifier panel. If it is a steady red, remove the rectifier and re-install it after the indicator turns off.
- If the alarm still exists, replace the rectifier.

Rect protection fault

A Rect protection fault has occurred.

Details

- The rectifier input voltage is too high.
- The rectifier input voltage is too low.
- The ambient temperature is too high.
- The rectifier is faulty.

Resolution

- Check if the AC input voltage exceeds the upper threshold of the rectifier working voltage. If yes, fix the power supply fault and restore the power supply.
- Check if the AC input voltage is below the lower threshold of the rectifier working voltage. If yes, fix the power supply fault and restore the power supply.
- Check if the ambient temperature is higher than the normal operating temperature of the rectifier. If yes, check and fix the temperature unit fault.
- Remove the rectifier generating the alarm and re-install it after the indicator turns off.
- If the alarm still exists, replace the rectifier.

Rect comm fault

A Rect comm fault has occurred.

Details

- The rectifier has been removed.
- The rectifier does not have good contact.
- The rectifier is faulty.

Resolution

- Check if the rectifier has been removed. If yes, re-install it.
- If the rectifier is in position, remove the rectifier and re-install it
- If the alarm still exists, replace the rectifier.

Temp Sensor x fault

A Temperature sensor x fault has occurred.

Resolution

1. Log into the Remote Power Shelf Rectifier.
2. Navigate to **Battery > Temperature**.
3. From the Temp Sensor 1 field, select **No**.
4. Select **Set**.

Identifying component faults

This section provides guidelines to help troubleshoot various component faults.

Identifying DC SPD faults

Check if the positive and negative poles of the DC lightning protection board are turned on. Non-conducting means normal and conducting means the DC lightning protection board is faulty.

Identifying rectifier faults

A rectifier is damaged if any of the following conditions is not met:

- When the rectifier does not communicate with the controller and the AC input voltage is around 220 VAC, the green indicator on the rectifier is steady on, the yellow indicator is blinking, the red indicator is off, and the rectifier output is normal.
- The controller can perform equalized charging, float charging, and current limiting control for the rectifier when the communication cable to the rectifier is correct.

Identifying controller faults

The following are the main symptoms of controller faults:

- The DC output is normal while the green indicator on the controller is off.
- The controller breaks down or cannot be started. Its LCD has an abnormal display or the buttons cannot be operated.
- With the alarm reporting enabled, the controller does not report alarms when the power system is faulty.
- The controller reports an alarm while the power system does not experience the fault.
- The controller fails to communicate with the connected lower-level devices while the communications cables are correctly connected.
- Communication between the controller and all the rectifiers fails while both the rectifiers and the communications cables are normal.
- The controller cannot control the AC or DC power distribution when communications cables are intact and the AC and DC power distribution is normal.

- Parameters cannot be set or running information cannot be viewed on the controller.

